

DIRIS B

Multifunction measuring unit - PMD

measurement, monitoring and event analysis with smart sensors - modular format



diris_b_038 eps

The solution for

- > Industry
- > Building
- > Infrastructure
- > Local authority



Strong points

- > Plug & Play
- > Global accuracy class 0.5 in accordance with IEC 61557-12
- > Multi-circuit
- > Communication

Integrated technologies



For more information see our website www.socomec.com

Conformity to standards

- > UL E257746
- > IEC 61557-12
- > EN 50160
- > ISO 14025



Configuration
with Easy Config System.

Function

The DIRIS B is a power monitoring device in a modular format that communicates via RS485. The 4 RJ12 independent current inputs of the device allow it to manage several types and number of circuits: for example, 4 single-phase loads or 1 three-phase load + 1 single-phase load.

The DIRIS B is connected to current sensors (RJ12 connection) that are suitable for all types of installation: solid TE, split-core TR/ITR, and flexible TF current sensors.

Advantages

Plug & Play

A rapid RJ12 connection makes wiring easy and reliable and prevents wiring errors. Automatically addressing and configuring the product (communication address, load type, type and ratio of current sensor) allow you to simplify implementation and to save time.

Class 0.5 in accordance with IEC 61557-12



- Class 0.2 for the meter alone.
- Class 0.5 from 2% to 120% of nominal current for the global measurement chain (associated with TE/ITR/TF current sensors).

Multi-circuit

- 4 current measurement inputs allow you to configure multiple circuits in order to optimise the number of measurement devices per installation.

Communication

- The DIRIS B can be connected to:
 - a remote DIRIS D-30 screen for displaying measurement and metering data,
 - DIRIS Digiware M-50/M-70 gateways for centralisation and communication of data via Ethernet. DIRIS Digiware M-70 embeds WEBVIEW-M, a webserver for remote visualisation of measurement data,
 - optional modules for more communication options including a second RS485 port or PROFIBUS DP protocol. Digital or Analog input/output, as well as temperature input modules can also be connected.

Application	Local metering	Local analysis
		
DIRIS B	B-10 RS485	B-30 RS485
Number of current inputs	4	4
Metering		
± kWh, ± kvarh, kVAh	•	•
Load curves		•
Multi-tariff	•	•
Multi-measurement		
U12, U23, U31, V1, V2, V3, f	•	•
U system, V system	•	•
I1, I2, I3, In, ΣP, ΣQ, ΣS, ΣPF	•	•
P, Q, S, PF per phase	•	•
Predictive power	•	•
Ph/N unbalance	•	•
Ph/Ph unbalance	•	•
Current unbalance (Inba, Idir, linv, lhom, lnb)	•	•
Phi, cos Phi, tan Phi	•	•
Quality analysis		
THDv1, THDv2, THDv3, THDu12, THDu23, THDu31	•	•
THDi1, THDi2, THDi3, THDin	•	•
Individual harmonics U & V (up to 63 rd)		•
Individual harmonics I (up to 63 rd)		•
Crest factor I1, I2, I3, In		•
Crest factor V1, V2, V3, U12, U23, U31		•
Voltage dips, interruptions, swells (EN 50160)		•
Overcurrents		•
Alarms		
On threshold		•
Inputs/outputs		•
History of average values		
45 days (max)		•
Communication		
RS485 Modbus	•	•
2 inputs (status/pulse)	•	•

Accessories

DIRIS B sealing cover

- Prevents access to the cabling of the monitoring device.

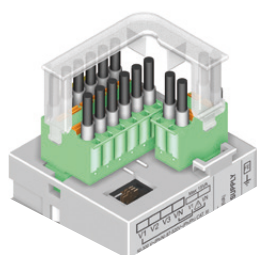

USB configuration cable (2 m)

- Advanced configuration of DIRIS B gateways can be achieved using the EASY CONFIG software via Ethernet or direct USB connection.

DIRIS B

Multifunction measuring unit - PMD

measurement, monitoring and event analysis with smart sensors - modular format

DIRIS D-30 display

DIRIS D-30



Connection



Optional modules

DIRIS O

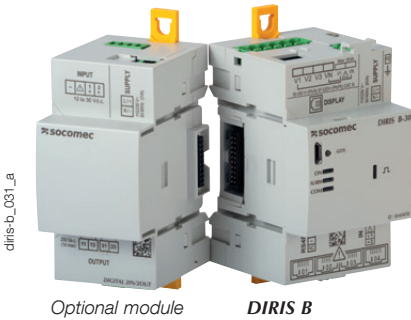

Optional modules (4 max.)*

- Digital inputs/outputs
- Analogue inputs/outputs
- Temperature inputs
- Communication protocols

* maximum 4 optional modules with maximum 1 temperature module and 1 communication module (Modbus, PROFIBUS).



DIRIS O-iod

- 2 digital inputs centralises the metering pulses or the input status changes of the auxiliary contacts.
- 2 digital outputs can be connected to configurable alarms warning of exceeded thresholds (power, current, etc.) or can be piloted remotely.



DIRIS O-ioa

- 2 inputs (4-20 mA) centralise analogue sensors (pressure, humidity, temperature, etc.)
- 2 outputs (4-20 mA) report the measurements (power, currents, etc.) to PLCs.



DIRIS O-it

- 3 temperature inputs to be connected to PT100 or PT1000 sensors.
- Ambient air temperature.



DIRIS O-m

- Provides a second RS485 Modbus communication port to the DIRIS B for simultaneous sending of information via RS485 to two supervision stations.



DIRIS O-p

- Adds a PROFIBUS DPV1 communication port to the DIRIS B.

DIRIS B terminals

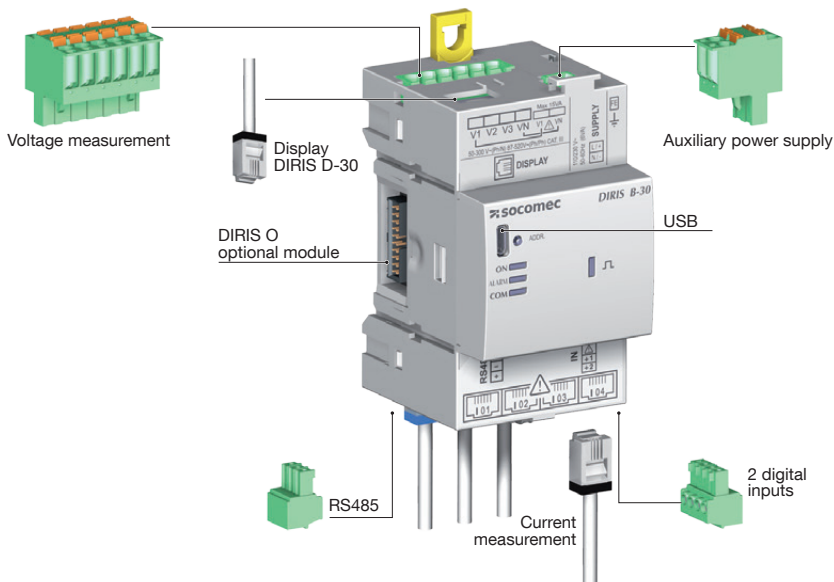

diris-d_027_b_1_gb_cat

Current measurement

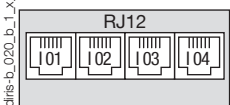

Voltage measurement and auxiliary power supply

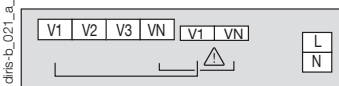

2 inputs supplied by the product

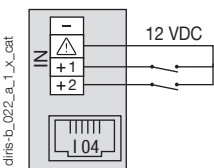

diris-b_022_a_1_x_cat

Self supply

Easy connection of the power supply from the measurement terminal (specific terminals)

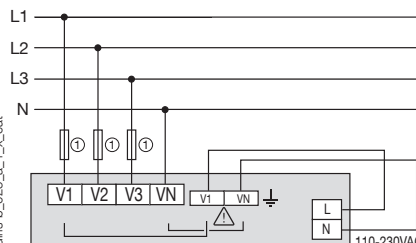

1. Fuses 0.5 A gG / 0.5 A class CC.

2 inputs with external power supply

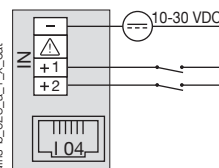

diris-b_023_a_1_x_cat

Separate power supply

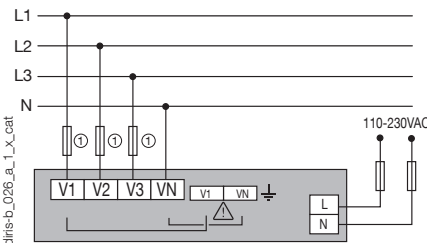

1. Fuses 0.5 A gG / 0.5 A class CC.

RS485

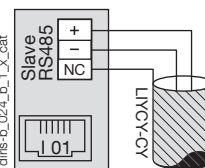

diris-b_024_b_1_x_cat

RJ9 for DIRIS D-30 (self-supply and data)



diris-b_019_a_1_x_cat

Terminals of optional DIRIS O modules

Optional module power supply

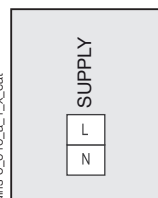

diris-o_010_a_1_x_cat

DIRIS O-iod

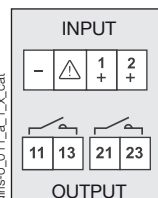

diris-o_011_a_1_x_cat

DIRIS O-ioa

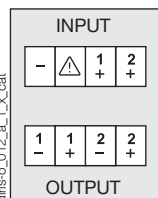

diris-o_012_a_1_x_cat

DIRIS O-it

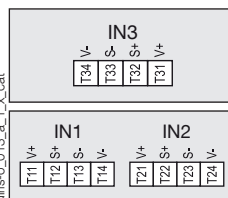

diris-o_013_a_1_x_cat

DIRIS O-m RS485

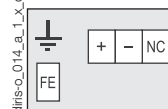

diris-o_014_a_1_x_cat

DIRIS O-p

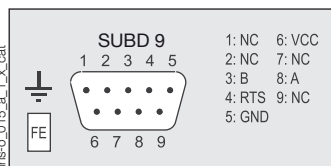

diris-o_015_a_1_x_cat

DIRIS B

Multifunction measuring unit - PMD

measurement, monitoring and event analysis with smart sensors - modular format

Connections

Associated current sensors

Various types of current sensors can be connected to the DIRIS B: solid-core TE, split-core TR/iTR, flexible TF current sensors. This range of sensors can be adapted to all types of new or existing installations. A rapid RJ12 connection makes wiring easy and reliable and prevents wiring errors. The DIRIS B automatically recognises the type of sensor used and its current rating. This guarantees the overall accuracy of the DIRIS B + current sensor measurement chain. For more information: see "TE, TR/iTR, TF sensors" pages.

TE solid-core current sensors

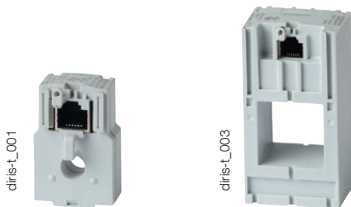

TR/iTR split-core current sensors



TE / TR / iTR / TF current sensors

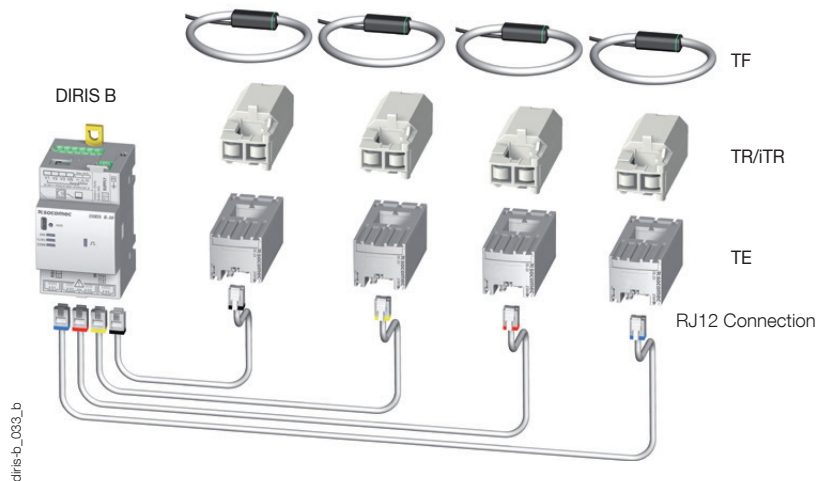

Network and connection examples

Three-phase + neutral

3P+N - 4CTs (measurement for 1 three-phase load + Neutral)

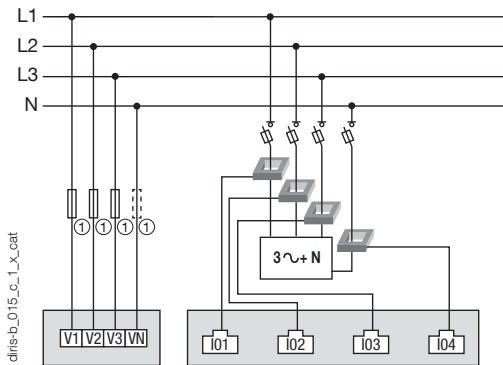

1. Fuses 0.5 A gG / 0.5 A class CC.

Three-phase

3P - 2CTs (2 three-phase loads without neutral)

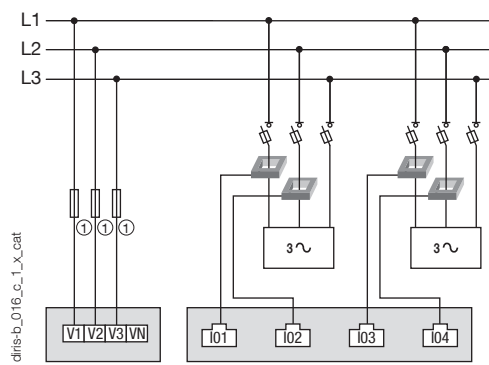

1. Fuses 0.5 A gG / 0.5 A class CC.

Three-phase

3P+N - 3CTs & 1P+N - 1CT (1 three-phase load & 1 single-phase load)

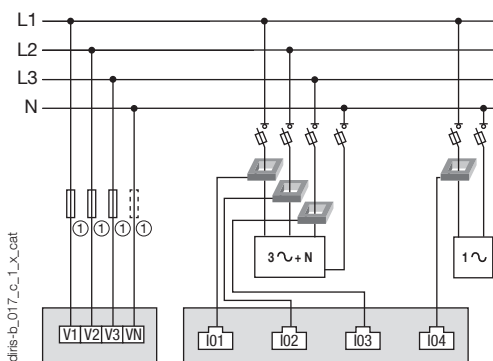

1. Fuses 0.5 A gG / 0.5 A class CC.

In case of self-supply, a fuse must be added on the neutral.

Single-phase

1P+N-1CT (4 single-phase loads)

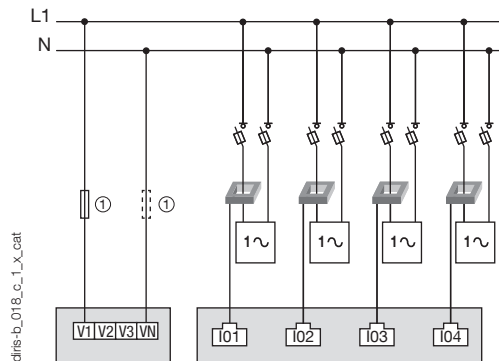

1. Fuses 0.5 A gG / 0.5 A class CC.



Dimensions (mm)

DIRIS B

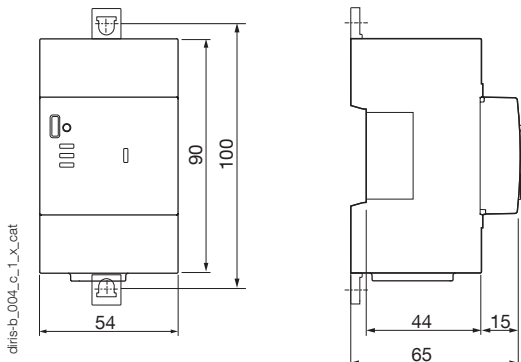

DIRIS O optional modules

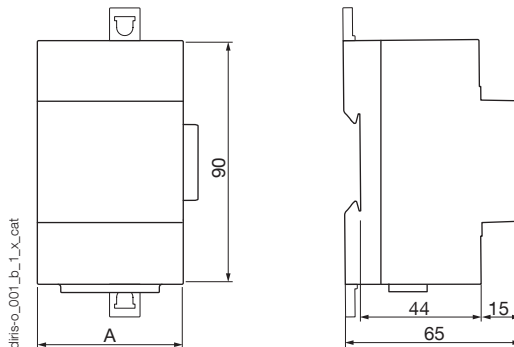

DIRIS O optional modules	A (mm)
DIRIS O-iod - DIRIS O-ioa - DIRIS O-it	45
DIRIS O-m - DIRIS O-p	54

DIRIS D-30

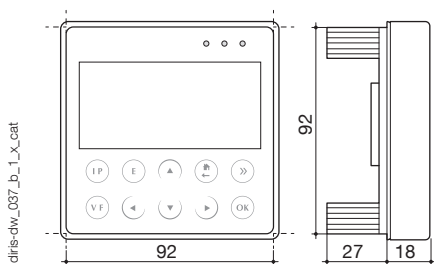

Communication architecture

Example of communication architecture with DIRIS Digiware M-70 gateway and WEBVIEW-M embedded web server.

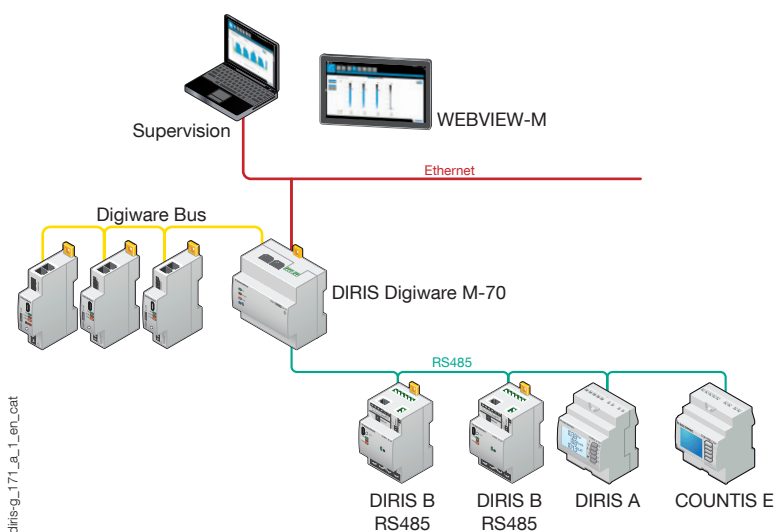

DIRIS B

Multifunction measuring unit - PMD

measurement, monitoring and event analysis with smart sensors - modular format

DIRIS B characteristics

Electrical characteristics

Auxiliary power supply	
AC voltage	110-230 VAC ±15 % (Ph/N ou Ph/Ph) Cat III
Frequency	50/60 Hz
Consumption	< 2 VA without display < 6VA with display
Connection	Removable spring-cage terminal, 2 x 2 positions, 0.5 ... 2.5 mm ² solid cable or 0.25 ... 1.5 mm ² stranded cable with ferrule

Measurement characteristics

Energy and power measurement	
Accuracy	Class 0.2 DIRIS B alone
Active energy and active power	Class 0.5 with TE, iTR or TF current sensors Class 1 with TR current sensors
Reactive energy accuracy	Class 2 with TE, TR or TF current sensors

Power factor measurement	
Accuracy	Class 0.5 with TE, iTR or TF current sensors Class 1 with TR current sensors

Voltage measurement	
Network characteristics measured	50-300VAC (PhN) - 87-520VAC (Ph/Ph) - CAT III
Frequency range	45 ... 65Hz
Frequency accuracy	Class 0.02
Network type	Single-phase / Two-phase / Two-phase with neutral / Three-phase / Three-phase with neutral
Measurement by voltage transformer	Primary: 400 000 VAC Secondary: 60, 100, 110, 173, 190 VAC
Input consumption	≤ 0.1 VA
Permanent overload	300VAC Ph/N
Voltage measurement accuracy	Class 0.2

Current measurement	
Number of current inputs	4
Associated current sensors	Solid TE , split-core TR/iTR , flexible TF current sensors
Accuracy	Class 0.2 DIRIS B alone Class 0.5 with TE, iTR or TF current sensors Class 1 with TR current sensors

Input characteristics	
Number	2
Type / Power supply	Optocoupler internal polarisation (12 VDC ± 10 %) or external polarisation (10-30 VDC ± 10%)

Communication characteristics	
DIRIS B RS485	
Link	RS485
Connection type	2 ... 3 half duplex wires
Protocol	Modbus RTU
Speed	1200 ... 115200 bauds
USB	DIRIS B RS485 configuration

Environment characteristics	
Operating temperature	-10 ... +70 °C
Storage temperature	-25 ... +85 °C
Operating humidity	55 °C / 97% relative humidity
Operating altitude	2000 m
Vibration	1G from 10 to 100Hz

DIRIS D-30 display characteristics

Mechanical characteristics	
Screen type	Capacitive touch-screen technology, 10 keys
Screen resolution	350 x 160 pixels
Single product connection	
RJ9	Self-supply and data
Micro-USB	Updating
Degree of protection	IP65 (front face)
Environment	
Storage temperature (°C)	-20 ... +70°C
Operating temperature (°C)	-20 ... +70°C
Humidity	95 % to 40°C
Installation category	CAT III
Degree of pollution	2

DIRIS O optional modules characteristics

Power supply ⁽¹⁾	
AC voltage	110-230 VAC ±15 %
Frequency	50/60 Hz

(1) No power supply on DIRIS O-it.

DIRIS O-iod - 2 digital inputs/2 digital outputs	
Number of inputs	2 per optional modules - max. 4 optional modules
Type	Optocoupler internal polarisation (12 VDC ± 10 %) or external polarisation (10-30 VDC ± 10%)
Function	Logic status or pulse meter
Number of outputs	2 per optional modules - max. 4 optional modules
Type	Relay / 230 VAC ±15 % - 1 A
Function	Configurable alarm (current, power...) on threshold overruns or remote controlled status
Inputs/Outputs connection	Removable screw terminal, 4 positions, 0.14 to 1.5 mm ² stranded or solid cable

DIRIS O-ioa - 2 analogue inputs/2 analogue outputs	
Number of inputs	2 per optional modules - max. 4 optional modules
Type	4-20 mA
Function	Connection of analogue sensors (pressure, humidity, temperature...)
Number of outputs	2 per optional modules - max. 4 optional modules
Type	4-20 mA

DIRIS O-it - 3 temperature inputs	
Number of inputs	3 external inputs + 1 measurement for ambient temperature
Dynamic	-20 ... 150 °C
Type	PT100 or PT1000

DIRIS O-m - RS485 communication	
Link	RS485 2 ... 3 half duplex wires
Protocol	Modbus RTU
Speed	1200 ... 115200 bauds
Connection	Removable screw terminal, 3 positions, 0.14 to 1.5 mm ² stranded or solid cable

DIRIS O-p - PROFIBUS communication	
Protocol	PROFIBUS DPV1

References

DIRIS B monitoring devices		Reference
DIRIS B-10	RS485 - Modbus - 230 VAC	4829 0010
DIRIS B-30	RS485 - Modbus - 230 VAC	4829 0000
DIRIS O optional modules		Reference
DIRIS O-iod	2 digital inputs / 2 digital outputs	4829 0030
DIRIS O-ioa	2 analogue inputs/2 analogue outputs 4-20 mA	4829 0031
DIRIS O-it	3 temperature inputs PT 100 / PT 1000	4829 0032
DIRIS O-m	RS485 Modbus communication	4829 0033
DIRIS O-p	PROFIBUS communication	4829 0034
Accessories	To be ordered in multiples of	Reference
DIRIS D-30 - Single-point display		4829 0200
RJ9 cable for DIRIS D-30 display - 1.5 m		4829 0280
RJ9 cable for DIRIS D-30 display - 3 m		4829 0281
DIRIS B sealing cover for I/O terminals		4829 0049
USB configuration cable		4829 0050
Fuse disconnect switches to protect voltage inputs (RM type)	4	5701 0018
Fuse disconnect switches to protect the 1-pole + neutral auxiliary power supply (RM type)	6	5701 0017
gG 10x38 0.5 A fuses	10	6012 0000