

# ATyS *d H*

Transfer Switching Equipment  
from 4000 to 6300 A



When **energy** matters

 **socomec**  
Innovative Power Solutions

# Why do you need Transfer Switching Equipment (TSE)?

Power outages can occur, even in high reliability distribution networks, leading to major incidents and losses on critical applications :

- Emergency systems.
- Healthcare facilities.
- Server rooms.
- Production lines.

To maximize your power availability, the Socomec range will safely transfer from any unstable or lost source to an alternate source. Furthermore, we ensure that you are prepared at all times thanks to our unique safety functions that facilitate maintenance on your low voltage electrical installation.

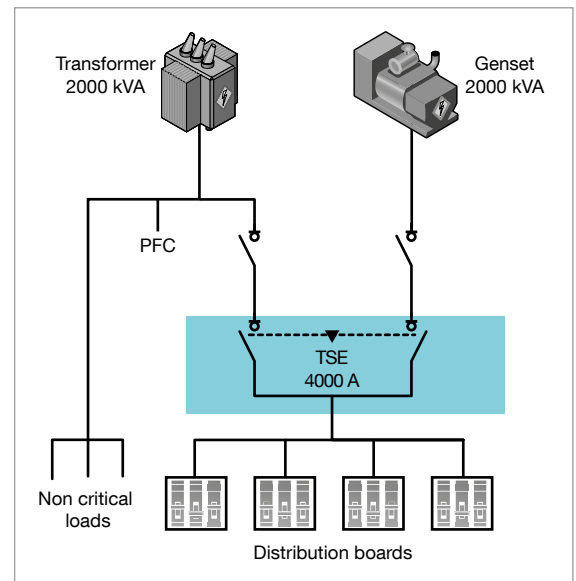

## Managing high ratings to provide maximum availability in your application

Contact us to find out how your application could benefit from ATyS d H.



### Data Center upstream secure transfer

Availability is one of the most used words in data centers. By combining a robust solution with high MTBF - quick to replace and easy to repair TSE - you have the assurance of high overall system availability, decreasing your data center downtime while securing your business.

### Ready to integrate in the enclosure of your choice

ATyS d H is a complete transfer switch that can be installed in any enclosure of your choice. All ratings maintain the same overall dimensions to make your system simpler than ever - and it is now possible to upgrade without changing the enclosure.



### Backup source transfer for industrial applications

For some processes, downtime is simply not an option. Even using a UPS with limited backup time to ensure continuity, most industries cannot afford to compromise on productivity and always include a backup source with a safe and integrated transfer solution.

# Why choose Socomec's *ATyS d H*?



Constant power availability keeps your activity safe and efficient. At Socomec, we have been designing, manufacturing and testing switchgear since 1922 and guarantee safe, reliable and long lasting Transfer Switching Equipment (TSE) for your electrical installation. All our solutions are fully compliant with Class PC of IEC 60947-6-1, the international product standard for TSE.

Today, more than 3 million installations and major integrators worldwide are secured with a Socomec transfer switch.



**Ready  
to integrate**

Complete functional unit with integrated interlocks ready to be installed in any enclosure of your choice.



**Easy  
to order**

Select from 3 or 4 pole, 4000, 5000 or 6300 A versions.



**Quick  
installation**

Connect the bars on the rear side of the ATyS d H and cable the control wires to any genset or ATS controller in the market. Forget about hard installations where you need to connect several products to make it work.



**Proven  
technology**

An integrated solution that has been engineered and tested according to IEC 60947-6-1 Class PC standard requirements for transfer switching.

# Main features

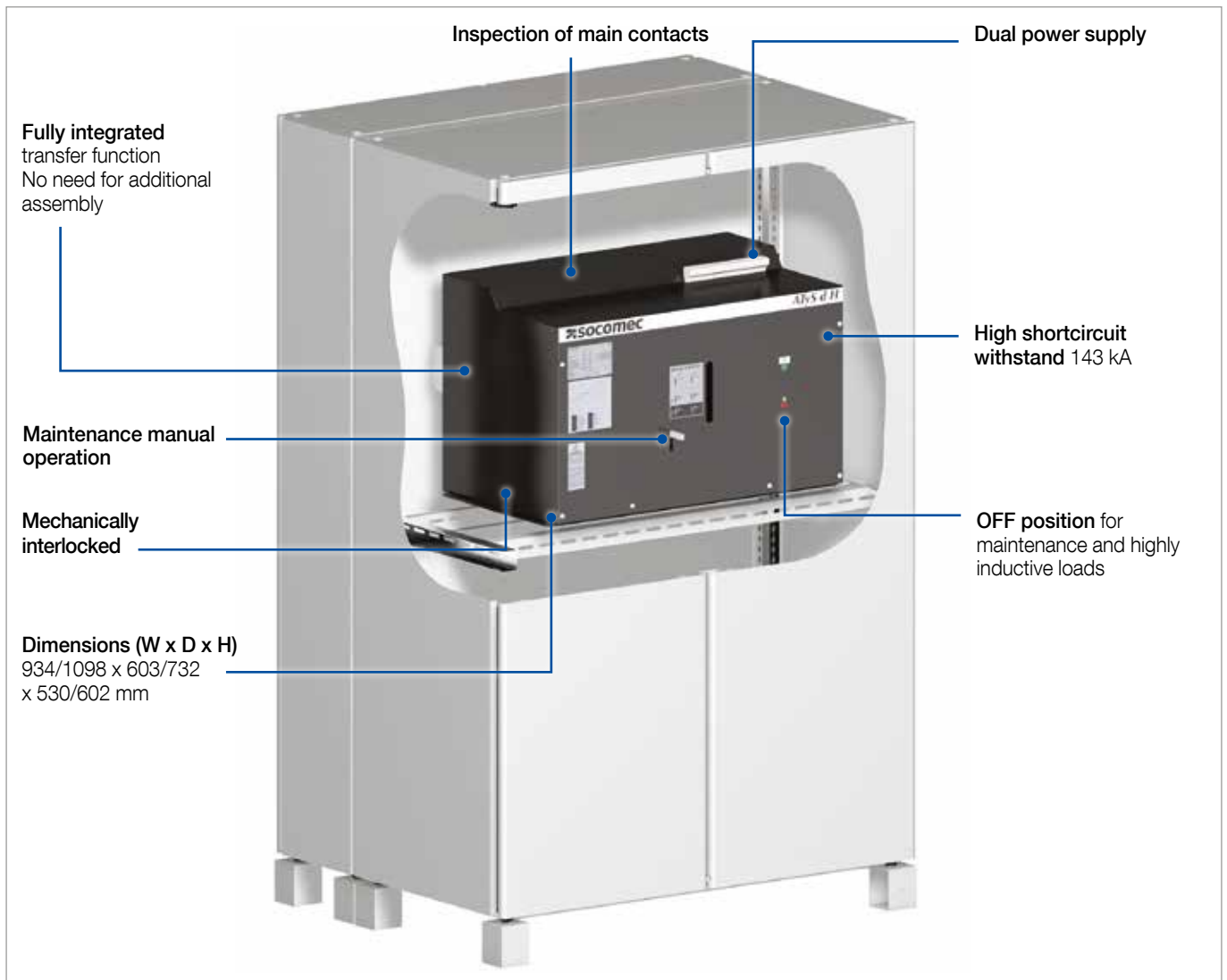

# Automate your transfer switch

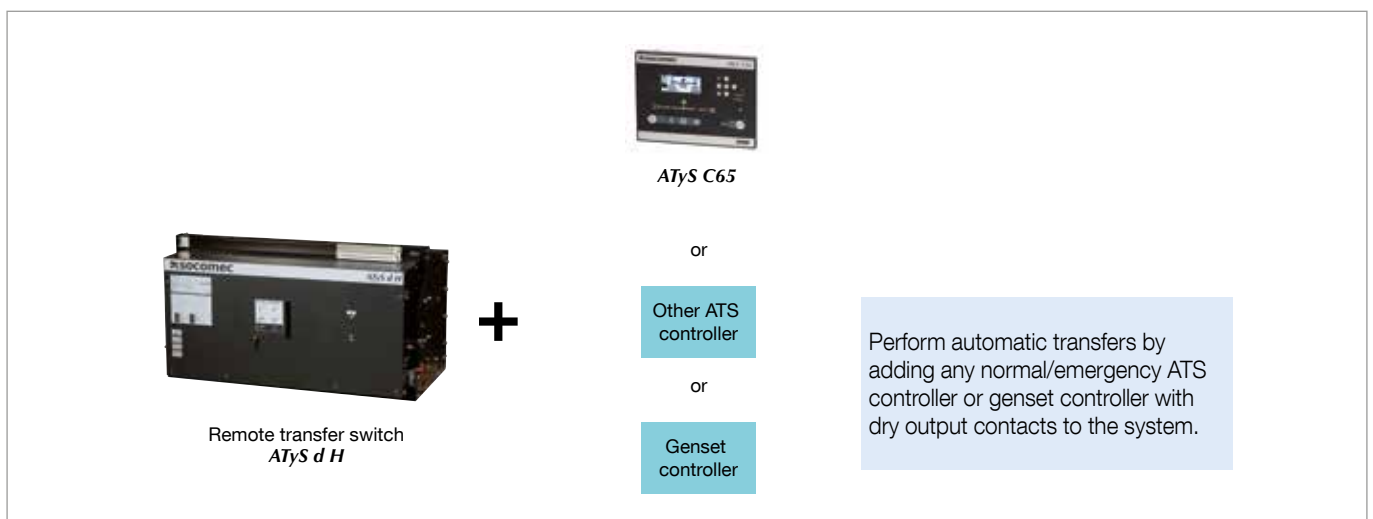

Remotely  
operated

Utilisation:  
Associated with any  
external genset or  
ATS controller













# Unique TSE for high power applications



ATyS d H

- Dual power supply
- Open transition (I-0-II) RTSE
- 3 or 4 poles version  
(only 2 sizes: 866 or 1096 width)

## A solution for every application

Manual	Remotely operated	Automatic	Enclosed
 <p><b>SIRCO VM1</b></p>	 <p><b>ATyS S &amp; d S</b>    <b>ATyS d M</b></p>	 <p><b>ATyS t M &amp; g M</b>    <b>ATyS p M</b></p>	 <p>&lt; 160 A</p>
 <p><b>SIRCOVER</b>    <b>SIRCOVER Bypass</b></p>	 <p><b>ATyS r</b>    <b>ATyS d H</b></p>	 <p><b>ATyS g</b>    <b>ATyS p</b></p>	 <p>&gt; 125 A</p>
DC		Static	Bypass
 <p><b>SIRCOVER PV</b></p>	 <p><b>ATyS S DC</b>    <b>ATyS r DC</b></p>	 <p><b>STATYS</b></p>	 <p><b>ATyS Bypass</b></p>

# Socomec: our innovations supporting your energy performance

**1** independent manufacturer

**3,600** employees  
worldwide

**10** % of sales revenue  
dedicated to R&D

**400** experts  
dedicated to service provision

## Your power management expert



POWER  
SWITCHING



POWER  
MONITORING



POWER  
CONVERSION



ENERGY  
STORAGE



EXPERT  
SERVICES

## The specialist for critical applications

- Control, command of LV facilities
- Safety of persons and assets
- Measurement of electrical parameters
- Energy management
- Energy quality
- Energy availability
- Energy storage
- Prevention and repairs
- Measurement and analysis
- Optimisation
- Consultancy, commissioning and training

## A worldwide presence

**12** production sites

- France (x3)
- Italy (x2)
- Tunisia
- India
- China (x2)
- USA (x3)

**28** subsidiaries and commercial locations

- Algeria • Australia • Belgium • China • Canada
- Dubai (United Arab Emirates) • France • Germany
- India • Indonesia • Italy • Ivory Coast • Netherlands
- Poland • Portugal • Romania • Serbia • Singapore
- Slovenia • South Africa • Spain • Switzerland
- Thailand • Tunisia • Turkey • UK • USA

**80** countries

where our brand is distributed

## India corporate office

**Socomec Innovative Power Solutions Pvt. Ltd.**  
B1, II Floor  
Thiru-Vi-Ka Industrial Estate  
Guindy, Chennai - 600 032  
Tel: +91 44 3921 5400 / 5466  
Mob: +91 9711229993, +91 9940633654  
info.in@socomec.com



## Manufacturing facility

**Socomec India Private Limited.**  
756 Pace City II  
Sector 37  
Gurgaon - 122 001  
Haryana  
Tel: +91 124 4562700, 4597803  
Fax: +91 124 4562733  
CIN: U00000HR1999PTC038504

## Regional & resident offices

Ahmedabad : +91 8939008184, +91 9727753931  
Bengaluru : +91 9886323448, +91 9972578171  
Chandigarh : +91 9023154784  
Chennai : +91 9940147003  
Cochin : +91 8939550688, +91 9745012322  
Coimbatore : +91 8939550688, +91 9003032012  
Hyderabad : +91 9642528800, +91 9959444277  
Indore : +71 9827674469  
Kolkata : +91 7550078077, +91 8697709095  
Mumbai : +91 9987052602, +91 8879791802  
New Delhi : +91 9953595413, +91 9958591713  
Pune : +91 8793144968, +91 9987052604  
Trivandrum : +91 9020179364  
Vadodara : +91 9099947988  
Vijaywada : +91 9515100473

## HEAD OFFICE

### SOCOMEK GROUP

SAS SOCOMEK capital 10 589 500 €  
R.C.S. Strasbourg B 548 600 149  
B.P. 60010 - 1, rue de Westhouse  
F-67235 Benfeld Cedex  
Tel. +33 3 88 57 41 41 - Fax +33 3 88 57 78 78  
info.scp.isd@socomec.com

## YOUR DISTRIBUTOR / PARTNER

[www.socomec.co.in](http://www.socomec.co.in)

