

NETYS RT

5 - 10 kVA UPS



Socomec Resource Center
To download, brochures, catalogues
and technical manuals

Download last release of installation and operating manual from:



AR	LT
CS	NL
DE	PL
EN	PT
ES	RO
FI	RU
FR	SL
HU	TR
IT	ZH



<https://qr2.socomec.com/ressource-center>



The safety information in this manual should be retained for future reference.



The reference information on safety is in English.



For other languages please contact Socomec or your local distributor.



The manufacturer will not be held liable for failure to follow the instructions in this manual which is also available at www.socomec.com

WARRANTY CERTIFICATE AND CONDITIONS

This Socomec appliance is guaranteed against manufacturing and material defects for a period of 12 months from the date of purchase (local warranty conditions are applicable in addition to the general conditions). This warranty certificate should NOT be e-mailed, but kept by the customer along with proof of purchase, for use in the event of a claim being made for repairs or replacement under warranty.

The warranty period commences on the date the new product was purchased by the end user at an authorised showroom (reference details are shown on the receipt).

Return-to-base warranty is provided: components and labour for repairs supplied free of charge, any products to be replaced must be returned to Socomec or authorised service centres, at the customer's own risk and expense.

The warranty is recognised within national territory. If the UPS is exported out of national territory, the warranty shall be limited to the cover of the parts used to repair the defect.

To claim service under the warranty please observe the following:

- The product must be returned in the original packing. Any damage caused during shipping in packaging other than the original will not be covered by the warranty;
- The product must be accompanied by proof of purchase such as an invoice or receipt indicating the date of purchase and product ID information (model, serial number). The sender must also attach the reference number issued to authorise the return of the product, together with a detailed description of the defect. If any of this information is missing the warranty will be invalid. The authorisation number is issued by service centres over the telephone on receiving information on the defect in question;
- If it is not possible to provide proof of purchase the serial number and date of manufacture will be used to calculate the probable expiry date of the warranty; this could result in a reduction of the original warranty period.

The warranty on the product does not cover damage caused by carelessness (improper use: wrong input power, explosions, excessive humidity, temperature, poor ventilation, etc.), tampering or any unauthorised repair work.

During the warranty period, Socomec reserves the right to decide whether the product should be repaired, or whether to replace defective parts with new parts, or used parts that are equivalent to new parts in terms of functionality and performance.

In the case of batteries, the warranty is valid only if the battery has been recharged regularly in accordance with the manufacturer's instructions. On purchasing the product it is advisable to check that the next recharge date indicated on the packaging has not expired.

VRLA Battery

- Batteries are treated as consumable parts and the warranty only covers manufacturing defects.
- Batteries must be stored in compliance with the supplier's recommendations.
- The warranty is valid only if the battery has been recharged regularly in accordance with the manufacturer's instructions. On purchasing the product it is advisable to check that the next recharge date indicated on the packaging has not expired.



Prior to use, the end user should take care to determine whether the environment and the load characteristics are suitable, adequate or safe for the installation and the usage of this product. The User Manual must be carefully followed. The vendor makes no representation or warranty as to the suitability or fitness of this product for any specific application.

Options

A 12-month return-to-base warranty is provided as an option.

Software products

Software products are guaranteed for 90 days. The software is guaranteed to work as indicated in the manual accompanying the product. Hardware media or accessories (e.g. diskettes, cables, etc.) used with appliances are guaranteed free of material or manufacturing defects under normal conditions of use for a period of 12 months from the date of purchase.

Socomec will not be responsible for damages (including loss of income, interruption of business activity, loss of information or other financial losses, of any nature) arising from the use of the product.

These conditions are subject to Italian law. Disputes shall come under the jurisdiction of the Court of Vicenza.

Socomec retains the full and exclusive ownership rights over this document. Only a personal right to use the document for the application indicated by Socomec is granted to the recipient of such document. All reproduction, modification or dissemination of this document whether in part or whole and by any manner are expressly prohibited except upon Socomec's express prior written consent.

This document is not a specification. Socomec reserves the right to make any changes to data without prior notice.

1. SAFETY INSTRUCTIONS	8
Special symbols	8
Safety of persons	9
Product safety.	12
Special precautions.	13
2. INTRODUCTION.	14
2.1. Product features	14
2.2. Environmental protection	15
2.3. Recycling	16
3. PRODUCT OVERVIEW.	17
3.1. Model name composition.	17
3.2. Weight and dimensions	18
3.3. Front panels.	19
3.4. Rear panels	20
3.5. LCD panel	22
3.6. LCD description.	24
3.7. Display functions	25
3.8. User settings	26
4. COMMUNICATION	27
4.1. RS232 and USB	27
4.2. UPS remote control functions	27
4.3. WEB/SNMP Card or Box (Option)	28
4.4. Programmable Relay I/O Card (Option NRT4-OP-ADC)	28
5. INSTALLATION.	29
5.1. Inspecting the equipment.	29
5.2. Unpacking the unit.	29

5.3. Checking the accessory kit	30
5.4. Installing the unit	31
5.5. Power cables connection.	34
5.5.1. Input /Output wiring	34
5.5.2. Access to terminal blocks (AC source to UPS).	35
5.5.3. Access to battery connector (DC source to UPS).	38
5.6. Parallel system Installation and Operation (Optional)	40
5.6.1. Wiring for AC Cable	40
5.6.2. Wiring for parallel signal cable	43
5.6.3. Parallel system Operation.	43
6. OPERATION	44
6.1. Starting the UPS using mains power	44
6.2. Starting the UPS using battery power	45
6.3. UPS shutdown.	45
7. UPS MAINTENANCE	46
7.1. Equipment care	46
7.2. Transporting the UPS.	46
7.3. Storing the equipment	46
8. TROUBLESHOOTING	47
8.1. Typical alarms and faults	48
8.2. Silencing the alarm.	49
9. SPECIFICATIONS.	50
9.1. UPS block diagram	50
9.2. UPS specifications.	51

1. SAFETY INSTRUCTIONS



SAVE THESE INSTRUCTIONS. This manual contains important instructions that should be followed during installation and maintenance of the UPS and batteries.

The UPS Rack/Tower models that are covered in this manual are intended for installation in an environment within an ambient temperature of 0°C to 45°C, free of conductive contaminant.

Special symbols



RISK OF ELECTRIC SHOCK - Observe the warning associated with the risk of electric shock symbol.



Important instructions that must always be followed.



EU separate collection and lead content mark for lead acid batteries. Indicates that the battery must not be disposed of in normal household waste but be separately collected and recycled.



EU separate collection mark for waste electrical and electronic equipment (WEEE). Indicates that the item must not be disposed of in normal household waste but be separately collected and recycled.



Environmental Protection Use Period (EPUP).



Information, advice, assistance.



Refer to the user manual.

Safety of persons

- This manual should be kept in a safe place near the UPS so that it can be consulted by the operator at any time for information that may be needed regarding correct use of the unit. Read the manual carefully before connecting the unit to the a.c. mains supply and the downstream appliances. Before the UPS is put into use the user should be completely familiar with its operation, the position of all the controls and the technical and functional characteristics of the unit, so as to ensure there will be no risk to persons or the appliance itself.
- Before being started, the unit must be equipotentially bonded, in accordance with current safety regulations. The earth wire of the UPS must then be connected to an efficient earth system.
- If there is no earth connection, the appliances connected to the UPS will not be equipotentially bonded. In this situation, the manufacturer declines all liability for any damage or accidents that could result from failure to observe the requirements.
- Should a power outage occur (UPS in stand-alone mode), do not disconnect the power cord from the mains, as this will break the earth connection to bonded appliances.
- All subsequent maintenance operations must only be performed by authorised service engineers. The UPS generates high internal voltages that could be hazardous for a maintenance operative not in possession of the appropriate skills and training for this type of work.
- If a hazardous situation should arise at any time when the UPS is in use, isolate the unit from the power supply (by operating a switch at the upstream PDU if possible) and switch the appliance off completely by running the shutdown procedure.
- Avoid exposing the UPS to contact with water or any liquids generally. Do not insert foreign objects into the cabinet.
- If the appliance is to be disposed of it should only be entrusted to a specialist waste disposal company. These companies will dismantle and dispose of the various components in accordance with statutory regulations in the country of purchase.
- Use the UPS in accordance with the technical specifications indicated in this manual.
- In the event that the equipment has no automatic backfeed protection contactor device, ensure that:
 - the user/installer attaches warning labels to all mains isolating switches located remotely from the area where the UPS is situated, in order to inform service personnel that the circuit is connected to a UPS.
 - an external isolating device is installed.

- The product you have selected, given the specified conditions of use, capacity and performance limits, is designed exclusively for commercial and industrial operation. Using the product in critical applications could require compliance with statutory regulations and standards, specific local bylaws, or adaptation to SOCOMEC recommendations. For this type of use it is always advisable to contact SOCOMEC beforehand for confirmation regarding the capacity of products to meet required levels of safety, performance and reliability. Critical applications include, in particular, life support systems, medical applications, commercial transport, nuclear facilities or any other systems where failure of the product might on occasion cause serious damage to persons or property.
- Skilled person is required for the installation.



NOTE!

These are products for commercial and industrial application – installation restrictions or additional measures may be needed to prevent disturbances.



WARNING

NRT4 5K and 6K models are category C2 UPS products. In a residential environment, these products may cause radio interference, in which case the user may be required to take additional measures.



WARNING

NRT4 8.5K – 10K models are products for commercial and industrial application in the second environment – installation restrictions or additional measures may be needed to prevent disturbances.

**CAUTION IF DAMAGED
NON-SPILLABLE BATTERIES**

Torn, crushed or damaged packaging which exposes the contents should be set aside in an isolated area and inspected by a qualified person. If the package cannot be shipped the contents must be promptly collected, segregated, and either the sender or recipient contacted.

- **RISK OF VOLTAGE BACKFEED.** The system has its own power source (the battery). Isolate the UPS and check for hazardous voltage upstream and downstream during lockout-tagout operation. Terminal blocks may be energised even if the system is disconnected from the AC power source.
- Dangerous voltage levels are present within the system. It should be opened exclusively by qualified service personnel.
- The system must be properly grounded.

- The battery supplied with the system contains small amounts of toxic materials. To avoid accidents, the directives listed below must be observed:
 - Servicing of batteries should be performed or supervised by personnel knowledgeable about batteries and the required precautions.
 - When replacing batteries, replace with the same type and number of batteries or battery packs.
 - Do not dispose of batteries in a fire. The batteries may explode.
 - Batteries constitute a danger (electrical shock, burns). The short-circuit current may be very high.
 - Never force, break or attempt to open the batteries. These batteries are sealed, maintenance-free components containing substances that are harmful to health and a source of environmental pollution. If liquid can be seen leaking from the battery, or a white powdery residue is noticeable, do not switch the UPS on.
 - Danger of explosion if the batteries are replaced with others of the wrong type.
 - Replaced batteries must be disposed of at authorised waste disposal centres.
 - It is very dangerous to touch any part of the batteries as there is no insulation between the batteries and the mains power source.

CAUTION!

A battery can present a risk of electrical shock and high short circuit current.

- Precautions must be taken for all handling:
 - Wear rubber gloves and boots.
 - Do not lay tools or metal parts on top of batteries.
 - Disconnect any charging sources prior to connecting or disconnecting battery terminals.
 - Check if the battery has been inadvertently grounded. If inadvertently grounded, remove the source from the ground. Contact with any part of a grounded battery can result in electrical shock. The likelihood of such shock can be reduced if such grounds are removed during installation and maintenance (applicable to equipment and remote battery supplies not having a grounded supply circuit).
 - Do not open or mutilate batteries. Released electrolyte is harmful to the skin and eyes. It may be toxic.
 - Failed batteries can reach temperatures that exceed the burn thresholds for touchable.

Product safety

- The UPS connection instructions and operation described in the manual must be followed in the indicated order.
- UPS enclosure IP rating IP20.
- CAUTION - To reduce the risk of fire, the unit connects only to a circuit provided with branch circuit overcurrent protection.
- The upstream circuit breaker for Normal AC/Bypass AC must be easily accessible. The unit can be disconnected from the AC power source by opening this circuit breaker.
- An additional AC contactor is used for back feed protection and must comply with IEC/EN 62040-1 (the creepage and clearance distances should meet the basic insulation requirements for pollution degree 2).
- Disconnection and overcurrent protection devices should be provided by others for permanently connected AC input (Normal AC/Bypass AC) and AC output circuits.
- Check that the indications on the rating plate correspond to your AC powered system and to the actual electrical consumption of all the equipment to be connected to the system.
- Never install the system near liquids or in an excessively damp environment.
- Never allow a foreign body to penetrate the system.
- Never block the ventilation grates of the system.
- Never expose the system to direct sunlight or source of heat.
- If the system must be stored prior to installation, storage must be in a dry place.
- The admissible storage temperature range is -25°C to +55°C without battery (-15°C to +40°C with battery).
- TN-S/IT/TN-C/TT of electrical supply system may be connected by UPS.

Special precautions

- The unit is heavy: wear safety shoes and preferably use a vacuum lifter for handling operations.
- All handling operations will require at least two people (unpacking, lifting, installation in a rack system).
- Before and after the installation, if the UPS remains de-energised for a long period, the UPS must be energised until the batteries are fully charged (see Battery Status on LCD).
- At least once every 6 months (for a normal storage temperature under 25°C). This charges the battery, thus avoiding possible irreversible damage.
- For three-phase AC input installation, this equipment complies with IEC 61000-3-12 provided that the short-circuit power S_{sc} is greater than or equal to 3.63 MW at the interface point between the user's supply and the public system. It is the responsibility of the installer or user of the equipment to ensure, by consultation with the distribution network operator if necessary, that the equipment is connected only to a supply with a short-circuit power S_{sc} greater than or equal to 3.63 MW.
- During the replacement of the Battery Module, it is imperative to use the same type and number of elements as the original Battery Module provided with the UPS to maintain an identical level of performance and safety.

2. INTRODUCTION

We recommend that you take the time to read this manual to take full advantage of the many features of your UPS.

Before installing your UPS, please read the booklet presenting the safety instructions. Then follow the indications in this manual.

The UPS settings can be protected by a user password: we kindly suggest to change it at the first UPS power up.

2.1. Product features

The uninterruptible power system (UPS) protects your sensitive electronic equipment from the most common power problems, including power failures, power sags, power surges, brownouts, line noise, high voltage spikes, frequency variations, switching transients, and harmonic distortion.

Special characteristics:

- Double converter with pure sine waveform output.
- Full digital control.
- Output PF = 1.
- High charger capability, the charger current is up to 12Amps.
- Smart charging method to expand battery life time.
- EBM quantity auto detection.
- Communication ports: RPO, Dry in, Dry out, intelligent slot, USB, RS232.
- Dot-matrix LCD, in multi-languages.
- ECO Mode.
- Battery-free start.

2.2. Environmental protection

Products are developed according to an eco-design approach.

Substances

This product does not contain CFCs, HCFCs or asbestos.

Packing

To improve waste treatment and facilitate recycling, separate the various packing components.

- The cardboard we use comprises over 50% of recycled cardboard.
- Sacks and bags are made of polyethylene.
- Packing materials are recyclable.

Follow all local regulations for the disposal of packing materials.

Product

The product is mainly made up of recyclable materials.

Dismantling and disassembly must take place in compliance with all local regulations concerning waste. At the end of its service life, the product must be transported to recycling centers, re-use and treatment facilities for waste electrical and electronic equipment (WEEE).

Battery

The product contains lead-acid batteries that must be processed according to applicable local regulations concerning batteries.

The battery may be removed to comply with regulations and in view of correct disposal.

2.3. Recycling



Contact your local recycling or hazardous waste centre for information on proper disposal of the used equipment.



Do not dispose of the batteries in a fire. This may cause battery explosion. The batteries must be correctly disposed of according to local regulations.



Do not open or destroy the batteries. Escaping electrolyte can cause injury to the skin and eyes. It may be toxic.



Do not dispose of batteries in the trash.

This product contains sealed lead acid batteries and must be disposed of correctly as explained in this manual. For more information, contact your local recycling centres, re-use and treatment facilities.



The crossed-out wheeled bin symbol indicates that waste electrical and electronic equipment should not be discarded together with unseparated household waste but must be collected separately. The product should be handed in for recycling in accordance with the local environmental regulations for waste disposal.

By separating waste electrical and electronic equipment, you will help reduce the volume of waste sent for incineration or land-fills and minimise any potential negative impact on human health and environment.

3. PRODUCT OVERVIEW

3.1. Model name composition

UPS model name composition:

NRT4-U	SSS	CCCC
--------	-----	------

NRT4-U	SSS	CCCC
Model name - prefix	Size	Configuration
	050 = 5 kVA monophase	-C = electronic cards coated
	060 = 6 kVA monophase	LB = long backup time (enhanced battery charger)
	080 = 8,5 kVA monophase	LB – C = long backup time (enhanced battery charger) + electronic cards coated
	100 = 10 kVA monophase	-ES = (for CEI 016 standard)
	108 = 8,5 kVA multiphase	
	110 = 10 kVA multiphase	

Note: in the following pages the specifications are referenced to multiple product configurations in this way:

NRT4-USSS.. stands for UPS SSS size, any configurations.

NRT4-USSSLB.. stands for UPS SSS size, configuration LB and LB-C

EBM model name composition:

NRT4-B	SSS	CC
--------	-----	----

NRT4-B	SSS	CC
Model name - prefix	Size	Configuration
	060 = 192Vdc	(nothing) = Normal life battery
	100 = 240Vdc	-L = long life battery
		-0 = empty cabinet

Note: in the following pages the specifications are referenced to multiple product configurations in this way:

NRT4-BSSS... stands for EBM SSS size, any configurations.



The models are not available for all markets. Contact Socomec for more information.

3.2. Weight and dimensions

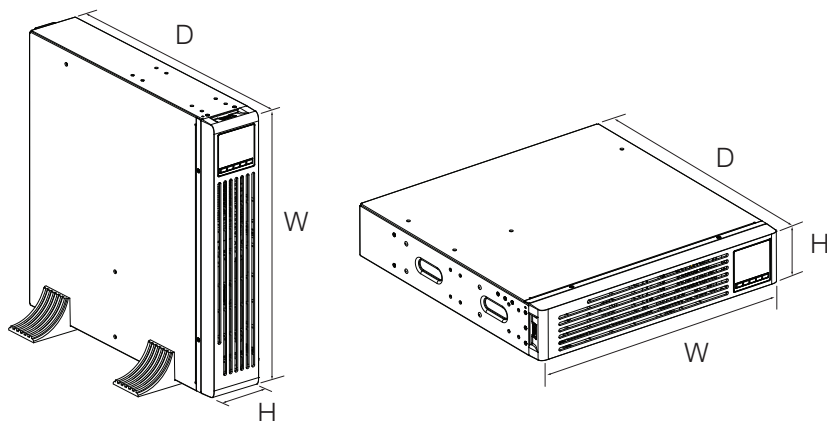

MODEL NAME	DESCRIPTION	NET WEIGHT (kg)	DIMENSIONS (mm) W x D x H
NRT4-U050...	NETYS RT 5000VA VFI UPS 1/1 PF=1	13.7	438 x 570 x 86.3 (2U)
NRT4-U060...	NETYS RT 6000VA VFI UPS 1/1 PF=1	13.7	
NRT4-U060LB...	NETYS RT 6000VA VFI UPS 1/1 PF=1 WITH POWERFUL CHARGER FOR EXTERNAL LONG AUTONOMY BATTERY	13.9	
NRT4-U080...	NETYS RT 8500VA VFI UPS 1/1 PF=1	15.2	
NRT4-U100...	NETYS RT 10000VA VFI UPS 1/1 PF=1	15.3	
NRT4-U100LB...	NETYS RT 10000VA VFI UPS 1/1 PF=1 WITH POWERFUL CHARGER FOR EXTERNAL LONG AUTONOMY BATTERY	15.5	
NRT4-U108...	NETYS RT 8500VA VFI UPS X/1 PF=1	15.8	438 x 570 x 86.3 (2U)
NRT4-U110...	NETYS RT 10000VA VFI UPS X/1 PF=1	15.8	438 x 570 x 86.3 (2U)
NRT4-U110LB...	NETYS RT 10000VA VFI UPS X/1 PF=1 WITH POWERFUL CHARGER FOR EXTERNAL LONG AUTONOMY BATTERY	16.0	
NRT4-B060...	NETYS RT NORMAL LIFE BATTERY CABINET FOR 5000VA AND 6000VA UPS + RAILS	40.8	438 x 600 x 85.5 (2U)
NRT4-B060-L...	NETYS RT LONG LIFE BATTERY CABINET FOR 5000VA AND 6000VA UPS + RAILS	42.9	
NRT4-B100...	NETYS RT NORMAL LIFE BATTERY CABINET FOR 8500VA AND 10000VA UPS + RAILS	60.0	438 x 590 x 129 (3U)
NRT4-B100-L...	NETYS RT LONG LIFE BATTERY CABINET FOR 8500VA AND 10000VA UPS + RAILS	64.0	



The weights in this table are for reference only, please see the labels on the carton for details.

Dimensions (D) is including front-panel.

3.3. Front panels

UPS (1-1) and (3-1)

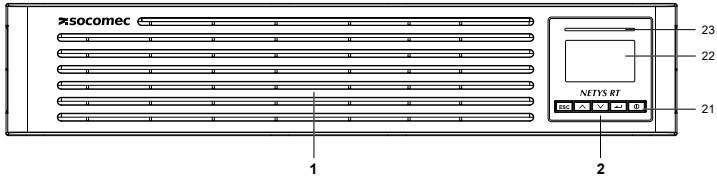

1. Ventilation area
2. LCD Modular, including:
 - 21. Button
 - 22. LCD screen
 - 23. LED indicator

EBM 192V 2U

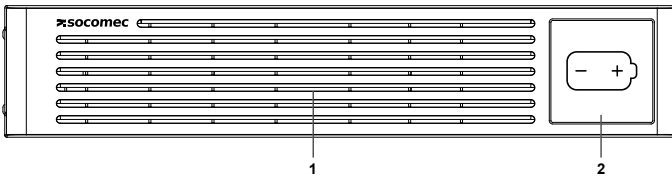

EBM 240V 3U

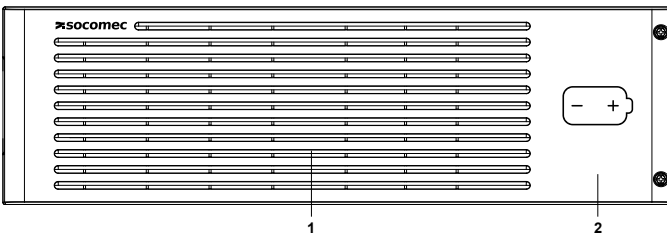

1. EBM ventilation area
2. EBM label area

3.4. Rear panels

UPS (1-1)

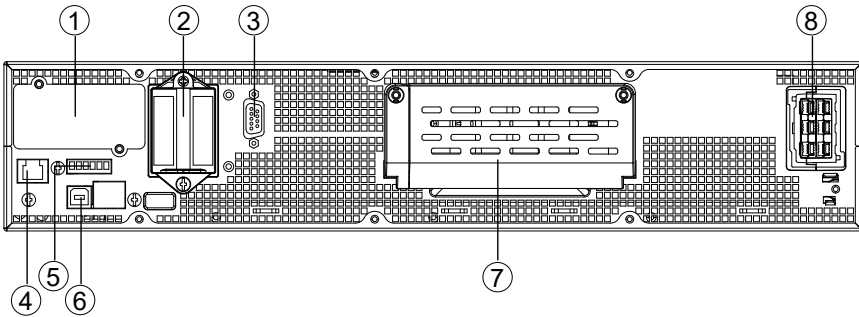

UPS (3-1)

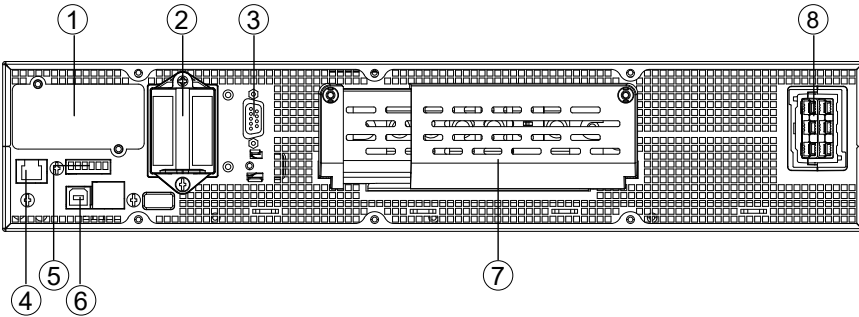

- | | |
|---|---|
| 1. INTELLIGENT SLOT | 5. RPO& DRY in/out |
| 2. PARALLEL SLOT | 6. USB |
| 3. RS232 | 7. AC Input /Output port (Terminal Block) |
| 4. RJ50 (for EBM detect /RT MBP detect) | 8. External battery port |

EBM 192V 2U

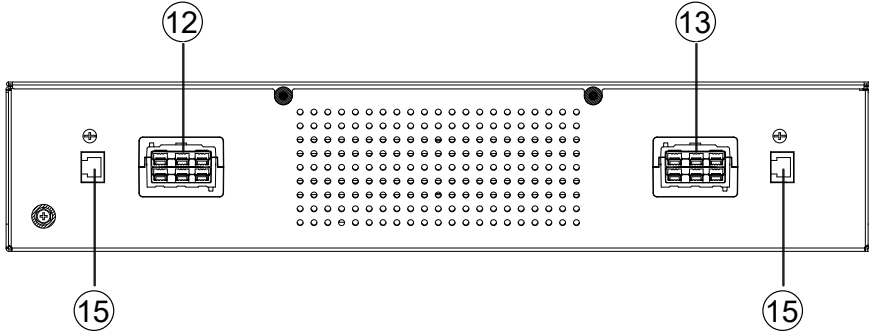

EBM 240V 3U

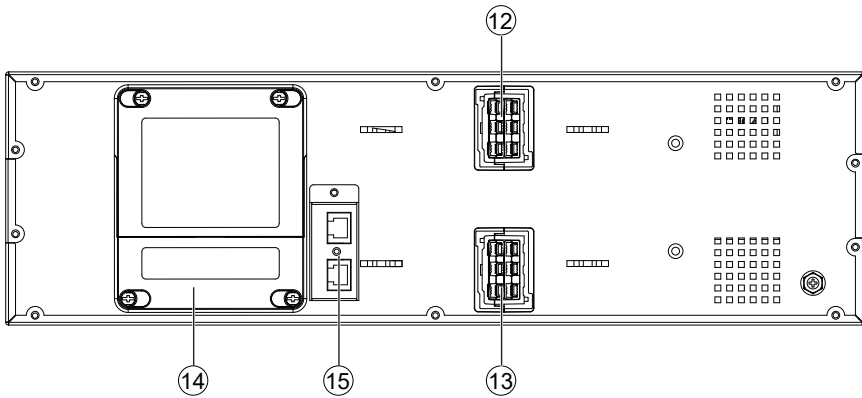







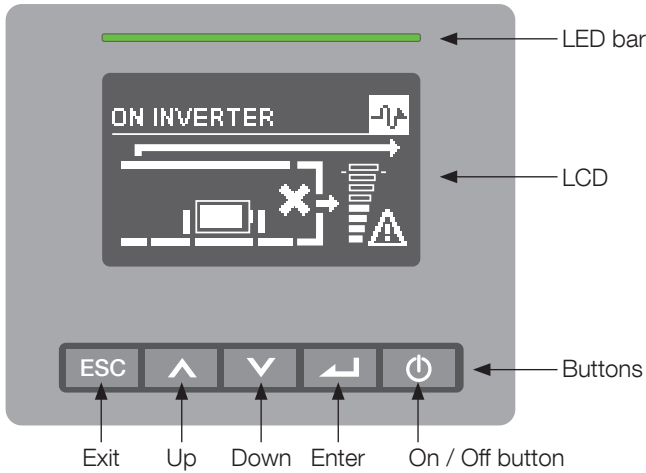



- 12. EBM port 1
- 13. EBM port 2
- 14. Fuse board cover (replace EBM fuse)
- 15. EBM detection Box (RJ50)

3.5. LCD panel





The UPS has a five-button graphical LCD. It provides useful information about the UPS itself, load status, events, measurements and settings.



The following table shows the LED bar status and description:

LED BAR	COLOR	GENERAL MEANING
	Off	Load not supplied on standby/off etc.
	Green	Load protected by inverter
	Green/off	Load supplied and UPS self-tested. (for example, when battery test is in progress)
	Green/Yellow	Load supplied and preventive alarm present
	Yellow	Load supplied with warning
	Yellow/Off	Maintain request/in progress
	Yellow/Red	Load supplied, but no longer protected
	Red	Load not supplied due to alarm
	Red/Off	Load not supplied, but the output will stop in a few minutes
	Yellow/Red/ green	No communication

The following table shows the Buttons status and description:

BUTTONS	FUNCTION	DESCRIPTION
	Power on	The Unit can be powered on by pressing the button for more than 100 milliseconds and less than 1 second, without utility input and battery connected
	Turn on	Press the button more than 3 seconds to turn on the UPS
	Turn off	Press the button more than 4 seconds to turn off the UPS
	Scroll up	Press to scroll up the menu option
	Scroll down	Press to scroll down the menu option
	Enter menu	Select/Confirm the current selection
	Exit the present menu	Press to exit present menu to main menu or the higher-level menu without changing the setting
	Mute buzzer	Press the button to mute the buzzer temporarily; once a new warning or fault is active, the buzzer will be activated again

NO.	STATUS	ALARM
1	Battery mode	Beep once every 4 seconds
2	Battery mode with battery low	Beep once every second
3	Bypass mode	Beep once every 2 min.
4	Overload	Beep twice every second
5	Warning active	Beep once every second
6	Fault active	Beep continuously
7	Button function active	Beep once

The buzzer will be temporality silenced if one or more alarms are active and silence button is pressed. The buzzer will beep again if any new alarm becomes active.

Backlight

The LCD backlight automatically dims after 10 minutes of inactivity. Press any button to restore the screen.

3.6. LCD description

Status screen:

The LCD backlight automatically dims after 10 minutes of inactivity. Press any button to restore the screen.

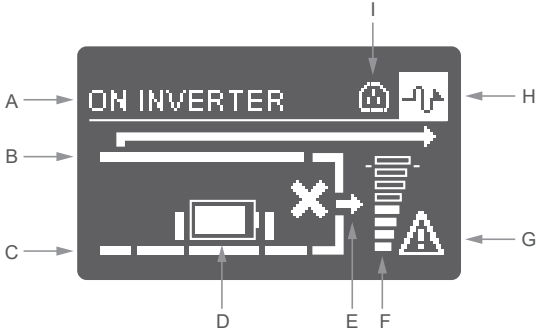

AREA	DESCRIPTION	DETAIL DESCRIPTION	
A	UPS status	On mnt. BP, Im. STOP, On battery, Battery test, On Inverter, Normal mode, Eco mode, On bypass, Standby, OFF	
B	Bypass input	On: Bypass input ok Off: Bypass input NOT ok	
C	Main input	On: Main input ok Off: Main input NOT ok	
D	Battery status	Symbol	On: Battery ok Off: No battery Flashing: Battery alarm
		Status	Battery open Battery discharging Battery charging
		Capacity	1 vertical line for 5% % value for charging, backup time for discharging
E	Output	On: on inverter or on bypass Off: no output	
F	Load status	8 steps for 0%-100% load Top bar flashing: UPS is overloaded	
G	Alarm icon	On: general alarm Off: no alarm	
	Parallel icon	When the UPS is in parallel mode, icon will appears in the bottom right corner of the screen, in the same place as alarm warning icon. The warning icon will overlap the parallel icon when warning appears.	
H	Mode icon	Eco mode Standby mode No icon, normal mode	
I	Power share icon	On: Power share output is supplied Off: Power share output is not supplied	

3.7. Display functions

MAIN MENU	SUBMENU	DISPLAY INFORMATION OR MENU FUNCTION
UPS MODE		UPS mode, date/time, battery status ⁽¹⁾ , parallel information and current alarms
HISTORY		Displays the events and faults stored
MEASUREMENTS		[Load] W VA A P%, [Input L1/Output] V Hz, [Input L2/Input L3] V Hz(if they exist),[Battery] % min V Ah, [DC Bus] V, [Temperature] °C
COMMANDS	Load segment	Load segment enable or disable
	Start battery test(single mode)Single battery test (parallel mode)	Starts a manual battery test in stand-alone mode Or starts a single battery test in parallel mode
	Parallel UPS battery test (parallel mode)	Starts a manual battery test in parallel mode
	Single UPS turn off (parallel mode)	Operate this machine to exit parallel connection
	Reset fault state	Clear active fault
	Reset history	Clear events and faults
	Restore factory settings	Restore to default factory settings
PARAMETERS		Refer to User settings
SERVICE		[Model name], [Serial number], [firmware version]

(1) OBM description

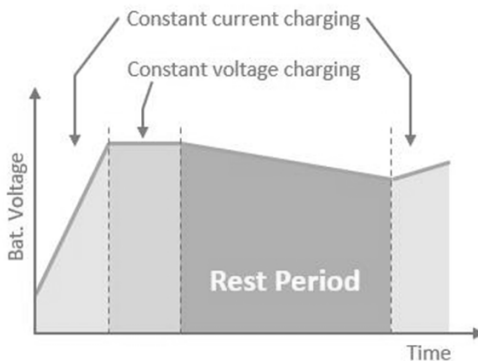

3.8. User settings

The following table displays the options that can be changed by the user.

SUBMENU	AVAILABLE SETTINGS	DEFAULT SETTINGS
Password	Can be changed by user	4732
Language	English, Français, Deutsch, Español, Русский, Português, Italiano, Svenska, Polski, Magyar, 简体中文	English
User Password	[enable, ****], [disable]	enabled
Audible alarm	[enabled], [disabled]	enabled
Output voltage	[220V], [230V], [240V]	[230V]
Output frequency	[Autosensing], [converter 50Hz, 60Hz]	Autosensing
High efficiency	[disabled], [enabled]	disabled
Auto bypass	[disabled], [enabled]	enabled
Load Segment	[enabled], [disabled]	disabled
Start/Restart	Cold start: [disabled], [enabled] Auto restart: [disabled], [enabled]	enabled enabled
Site wiring fault	[enabled], [disabled]	disabled
Overload pre-alarm	[50%~105%]	105%
External battery	[Auto NL detection], [Auto LL detection] [Manual Ah: 0~300Ah]	Auto NL detection 0 Ah
Charger current	1 - 2 A for 5-6k 2 - 4 A for 8.5-10k 4 - 12 A for 5-10k LB models	1.4 A for 5-6K 2 A for 8.5-10k 4 A for 5-10k LB models
Dry in signal	[Disabled], [Remote on], [Remote off], [Forced bypass]	Disabled
Dry out Signal	[Load powered], [On bat], [Low bat], [Bat open], [Bypass], [UPS ok]	bypass
Ambient temperature alarm ⁽¹⁾	[enabled], [disabled]	enabled
Battery remaining time	[enabled], [disabled]	enabled
Backup time limit	[enabled: 30min.~999min.], [disabled]	Standard: disabled ES: enabled 60 min.
Remote control	[enabled], disabled]	disabled
Date / Time	dd/mm/yyyy hh:mm	01/01/2020 00:00
LCD contrast	[0-100%]	50%



Note: if the UPS is used in IT neutral systems, the site wiring fault function should be disabled.

(1) Temperature threshold 40°C.

4. COMMUNICATION

4.1. RS232 and USB

1. Communication cable to the serial or USB port on the computer.
2. Connect the other end of the communication cable to the RS232 or USB communication port on the UPS.

4.2. UPS remote control functions

- Remote Power Off (RPO)

When RPO is activated, the UPS will cut off output immediately, and continues to alarm.

RPO	COMMENTS
Connector type	1mm ² / 16 AWG Maximum wires
External breaker specification	60 V DC/30 V AC 20 mA max

Reset:

1. Check the RPO connector status;
2. Clear fault state through LCD.

- Programmable Dry in

The Dry in function can be configured (see Settings > Dry in).

DRY IN	COMMENTS
Connector type	1mm ² / 16 AWG Maximum wires
External breaker specification	60 V DC/30 V AC 20 mA max

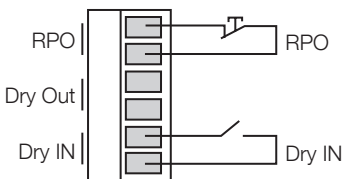

It is recommended the use of twisted and shielded cable, separated from the power cable.

- Programmable Dry out

The Dry out is a relay out, and the dry out function can be configured (see Settings > Dry out in section 3.8).

DRY OUT	COMMENTS
Connector type	1mm ² / 16 AWG Maximum wires
Inner Relay specification	24Vdc/1A

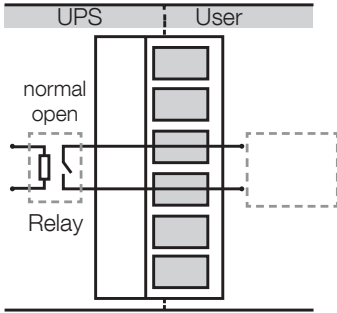

4.3. WEB/SNMP Card or Box (Option)

With this card installed, the UPS can be connected directly to a LAN (RJ45 ethernet) and controlled remotely from a WEB browser using TCP/IP protocol. Reference should be made to the relevant literature for a full description of functionality.



Note: enable the remote control to give the permission to the card to control the UPS.

4.4. Programmable Relay I/O Card (Option NRT4-OP-ADC)

This I/O relay card is a UPS management product with 5 relay output contacts for monitoring the status and 1 input contact as UPO, Battery Mode Shutdown, Any Mode Shutdown and Remote ON/OFF UPS.

Features:

- Monitor UPS events.
- 5 programmable relay output contacts.
- Configurable as normally open or normally closed for each relay contact.
- Input signal configurable as UPO, Battery Mode Shutdown, Any Mode Shutdown and Remote ON/OFF UPS.
- Can protect up to 5 computers.

5. INSTALLATION

It is recommended to move the equipment to the installation site by using a pallet jack or a truck before unpacking.

The system may be installed only by qualified electricians in accordance with applicable safety regulations.

The cabinet is heavy, please install it with at least two peoples.

5.1. Inspecting the equipment



If any part of the equipment has been damaged during shipment, keep the shipping cartons and packing materials for the carrier or place of purchase and file a claim for shipping damage.

5.2. Unpacking the unit



Unpacking the unit in a low-temperature environment may cause condensation occurred in and on the cabinet. Do not install the unit until the inside and outside of the unit are absolutely dry (hazard of electric shock). Remove the packing materials and lift the unit out with two people at least.



Note: The cabinet is heavy, please see spec weight provided on the carton/label.

Do not lift the unit by its front panel and rear panel.

Discard or recycle the packaging in a responsible manner, or store it for future use.

Packing materials must be disposed in compliance with all local regulations concerning waste. Recycling symbols are printed on the packing materials to facilitate sorting.

RT UPS

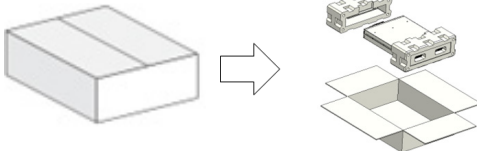

RT EBM*

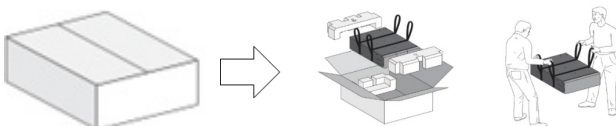

* 2U EBM without rope to lift the battery

5.3. Checking the accessory kit

Check that the following additional items are included with the unit.

	NRT4-U050 NRT4-U060 NRT4-U080 NRT4-U100	NRT4-U060LB NRT4-U100LB	NRT4-U108	NRT4-U110LB	NRT4-B060 NRT4-B100
Battery cable		√ ¹		√ ¹	√
EBM detection cable					√
Copper bus-bar			√	√	
USB cable	√	√	√	√	
Parallel cable kit	√	√	√	√	
Tower stands	√	√	√	√	
Extension plate of Tower stands					√
Rack ear kit	√	√	√	√	
Rack rail kit (80kg max load)	O	O	O	O	√
Safety instructions	√	√	√	√	√
Multilingual safety label guide	√	√	√	√	√
User manual	√	√	√	√	

√: Standard configuration; O: Optional, default is Not configured;

(1) one side free.

5.4. Installing the unit



The UPS supports 2 installation modes: Rack installation and Tower installation. To keep good ventilation, please keep a free-space (500mm at least) for front / rear panels of the module. Do not carry the front/rear panel of the module during installing.

- Rack installing

This procedure is suitable for 19 inch rack cabinet installation, it is recommended that the depth of the cabinet be no less than 800mm.

UPS model

Identify the final position and keep '2U' space for this installing.

1. Install the rail kit (if configured). This rail kit is '2U & with screw holes (M5)', the depth of the rail kit is: 445-1000 mm.

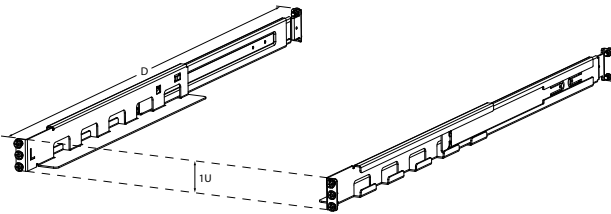

Fasten the rail kit to the cabinet with 8pcs M5 screws + washers (as below):

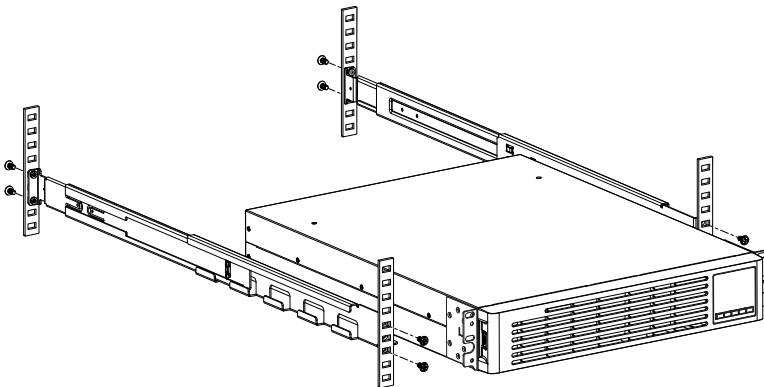

2. Install 'Rack ear' to the unit by the M4 screws (flat head).

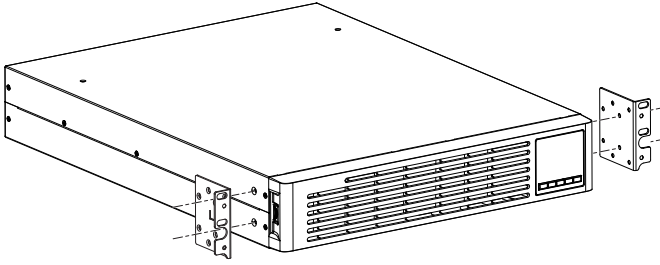

3. Slide the unit into 'rail kit' and make sure tighten the 'rack mounting screw'.

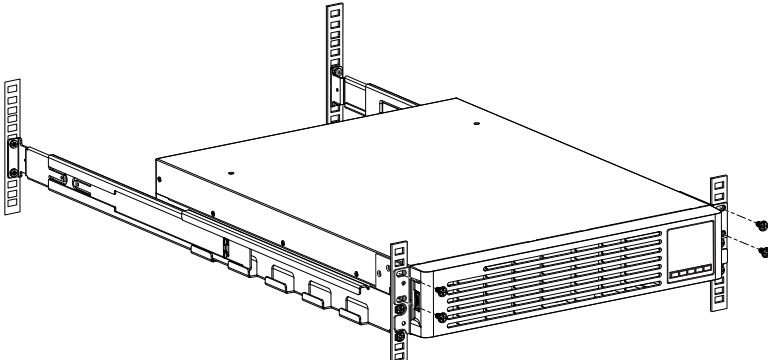

EBM (2U or 3U model)

Identify the final position and keep '2U' or '3U' space for this installing, and it is recommended to be installed below to UPS.

1. Install the rail kit(if configured): same as UPS as above.
2. Install 'Rack ear' to the unit by the M4 screws(flat head).

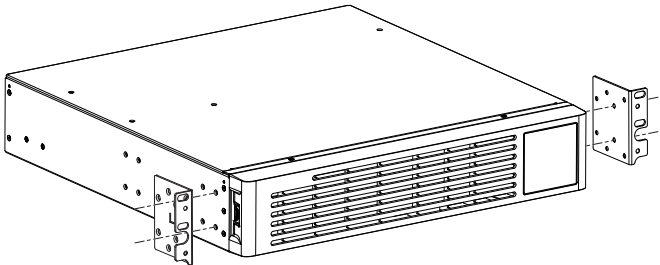

3. Slide the unit into 'rail kit' and make sure tighten the 'rack mounting screw'.

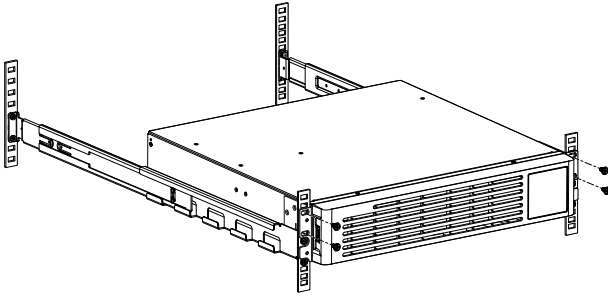

• Tower installing

UPS model

1. Rotate the LCD model to tower direction.

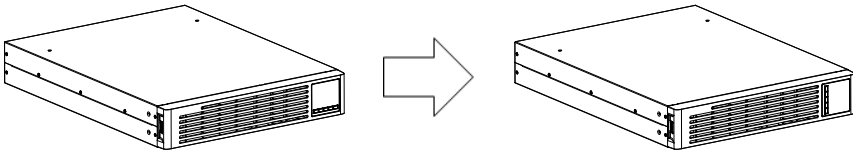

2. Set up the 'Tower foot', then take the unit into 'Tower foot'.

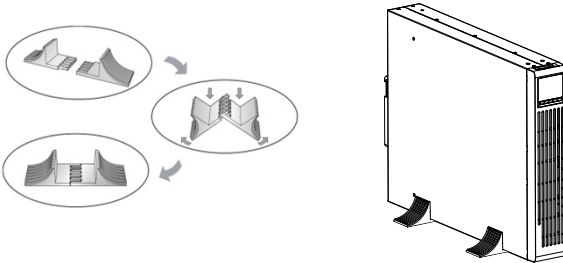

EBM model

1. Set up the 'Extension plate' as below and install to 'Tower foot' from UPS.
2. Take the UPS& EBM into 'Tower foot' individually: Place EBM modular to UPS's right side and align with front-panel.

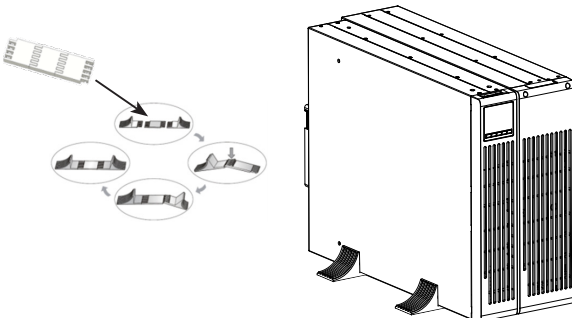

5.5. Power cables connection

This chapter explains how to wire the AC IN/OUT cable to different UPS models and how to connect the UPS with the EBM/MBP.

5.5.1. Input /Output wiring

Before wiring the UPS, the upstream breaker and backfeed contactor should be configured to avoid power backfeed to the unit. The “backfeed voltage danger” warning label should be added to the backfeed contactor or device. Before operating, the UPS input should be cut off, and check the voltage on all the terminals to avoid any dangerous voltages. Backfeed contactor rating current should be higher than UPS rating input current. The figures below show the wiring system of the UPS input and output.

Single phase input system

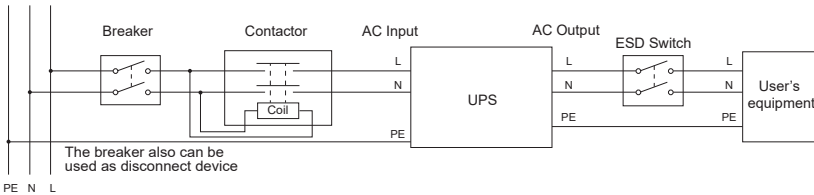

Three phase input system

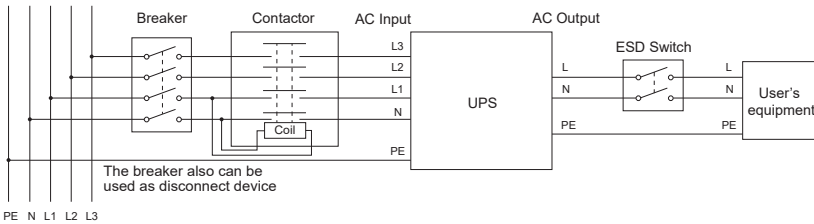

Danger! The rated current of the mains power supply switch must be higher than the UPS input current, otherwise the mains power supply switch may burn!



In three phase input system UPS the bypass connects directly input phase R to the output: in this condition the load is connected to one phase like it is on single phases input system UPS.

Recommended upstream protection and downstream switch:

UPS POWER RATING	UPSTREAM CIRCUIT BREAKER	UPSTREAM RCD	BACKFEED CONTACTOR	DOWNSTREAM SWITCH
5000 VA	D curve – 50 A (1 phase)	100 mA type A	50 A (1 phase)	40 A (1 phase)
6000 VA	D curve – 63 A (1 phase)	100 mA type A	63 A (1 phase)	40 A (1 phase)
8500 VA	D curve – 80 A (1 phase)	100 mA type A	80 A (3 phase)	63 A (1 phase)
8500 VA 3-1	D curve – 80 A (3 phase)	100 mA type A	80 A (3 phase)	63 A (1 phase)
10000 VA	D curve – 80 A (1 phase)	100 mA type A	80 A (1 phase)	63 A (1 phase)
10000 VA 3-1	D curve – 80 A (3 phase)	100 mA type A	80 A (3 phase)	63 A (1 phase)



Read the safety instructions regarding backfeed protection requirements.

Recommended cable minimum cross-sectional area:

MODEL	NRT4-U50/U60...	NRT4-U080/U100...	NRT4-U108/U110...
Protective earthing conductor ⁽³⁾	10 mm ²	10 mm ²	10 mm ²
Input L, N cable ⁽³⁾	6 mm ²	10 mm ²	10 mm ²
Output L,N cable ^{(1) (3)}	6 mm ²	10 mm ²	10 mm ²
Battery cable ^{(2) (3)}	6 mm ²	10 mm ²	10 mm ²

(1) The length of the output cable is recommended not to exceed 10 meters, otherwise, it may cause radio interference. If a length of output cable over 10 meters requests, please contact distributors/agents for details.

(2) It suggests to use standard 'battery cable' in package when connects battery pack with UPS. If additional battery cable needed for installation, it must follow cable specification and the maximum length of battery cable 10 meters for application. If a length of battery cable over 10 meters requests, please contact distributors/agents for details.

(3) Max cross-section area: 16 mm².

5.5.2. Access to terminal blocks (AC source to UPS)



High leakage current:
Earth connection essential before connecting supply.



This type of connection must be carried out by qualified electrical personnel. Before carrying out any connection, check that the upstream protection devices (Normal AC source and Bypass AC source) are open "O" (Off). Always connect the ground wire first.

1. Remove the cover of terminal block.
2. Connect the AC cable to terminal blocks:

1-1 model:

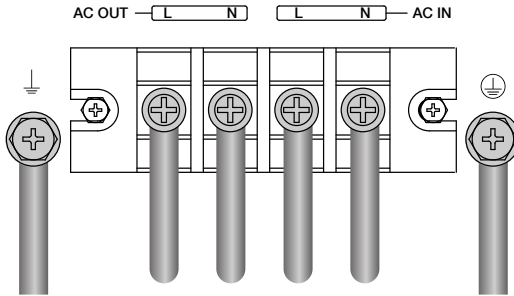

3-1 model:

1-1 configuration

Short 'UPS input terminal L1/L2/L3' with 'busbar', then connect the AC cable.

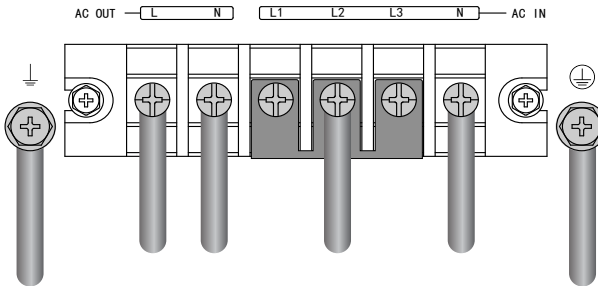

3-1 configuration

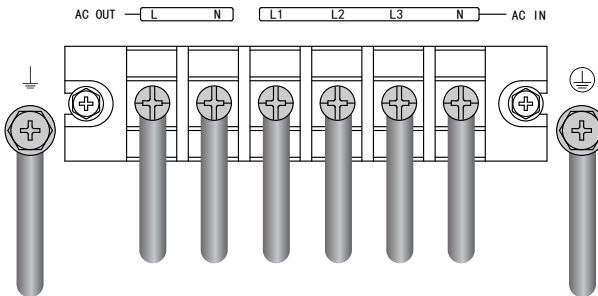



Note: for correct connection of the cables, it is recommended to connect these cables to the rear-panel as below:

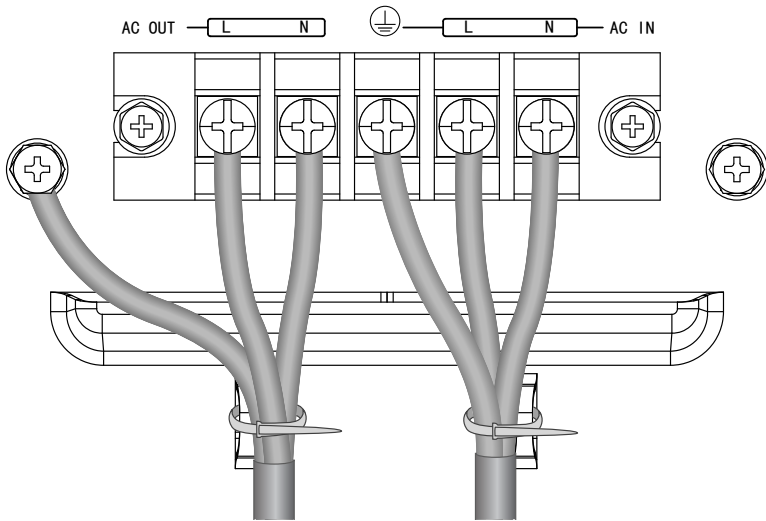

3. replace the cover of terminal block.

5.5.3. Access to battery connector (DC source to UPS)



1. Make sure the UPS is completely off before connecting or disconnecting the EBM.
2. Before connecting the EBM, make sure that the EBM specification is compatible with UPS configuration.
3. Do not reverse the polarity of the external battery.
4. These battery cabinets are part of a SOCOMEC UPS systems.
5. Be sure to use these battery cabinets only with the suitable SOCOMEC UPS.
6. Make sure to disconnect the battery cable from the EBM before connecting the battery terminals of the UPS.

- Connect with the configured EBM:

Connect EBM to UPS with 'Battery cable' and 'EBM detection cable'

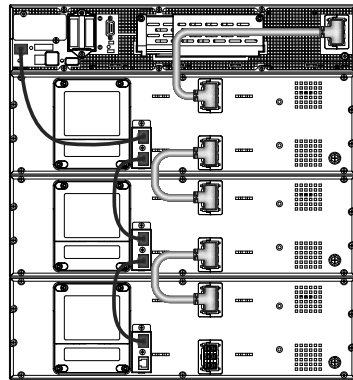
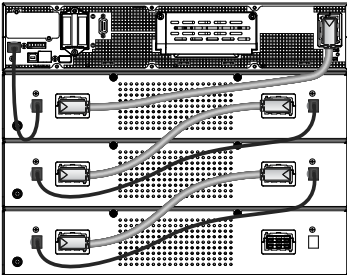

- Connect with user's own EBM:

Connect EBM to UPS with 'Battery cable'(optional configured)

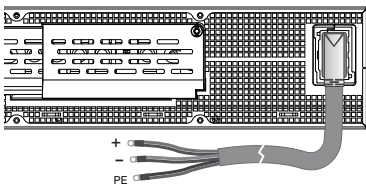

- Wiring with NRT4-OP-MBP (NRT4-OP-MBP source to UPS only)

NRT4-OP-MBP is UPS's optional modular, UPS can be used with the NRT4-OP-MBP to implement the maintenance bypass switching function to ensure that the output of the system is not affected during the UPS maintenance.

See the User Manual of NRT4-OP-MBP for details.

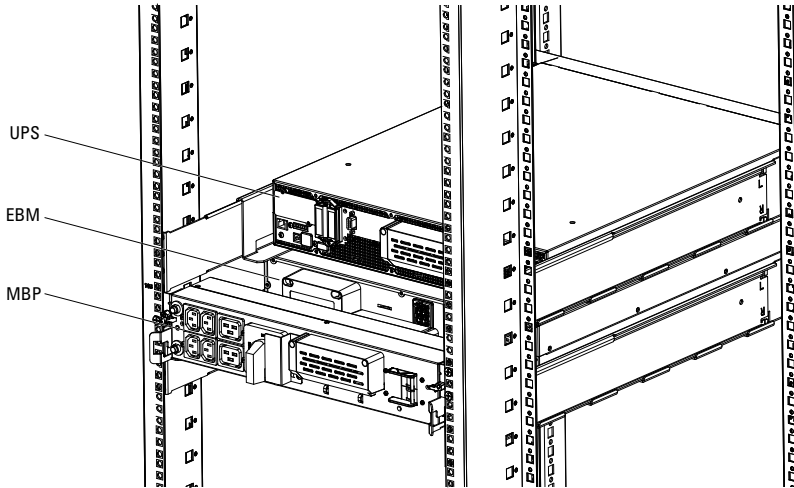

5.6. Parallel system Installation and Operation (Optional)

If your UPS is configured with parallel function, up to 3 UPSs can be connected in parallel to configure a sharing and redundant output power.

In parallel system, the mechanical installation for each modular is same as the single system. Details please refer to Chapter 5.5.

Parallel system AC cable diagram:

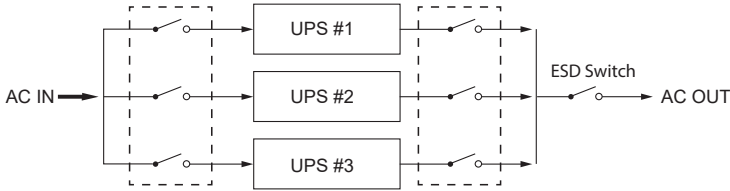

5.6.1. Wiring for AC Cable

1. Wiring length requirement:

When the distance between the load and the parallel UPS is less than 10 meters, the length difference between the input/output lines between the UPSs in the parallel system is less than 20%.



When the distance between the load and the parallel UPS is greater than 20 meters, the length difference between the input/output lines between the UPSs in the parallel system is less than 5%.

3. In the parallel system, common battery application is not supported. independent EBM connect to each UPS, please refer to chapter 5.5.3.
4. Professional installation is required, please set the parallel system in the restricted area!

• 1-1 model

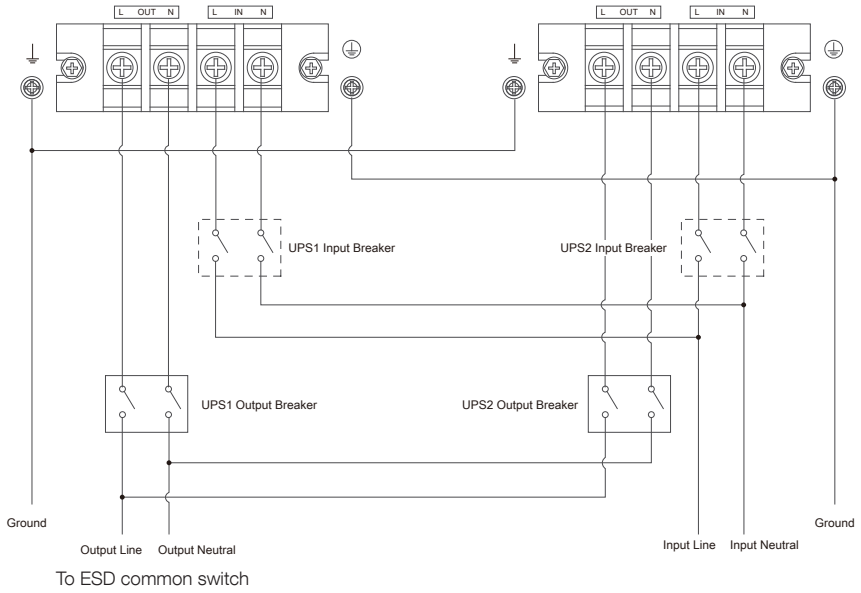

- 3-1 model

1-1 mode

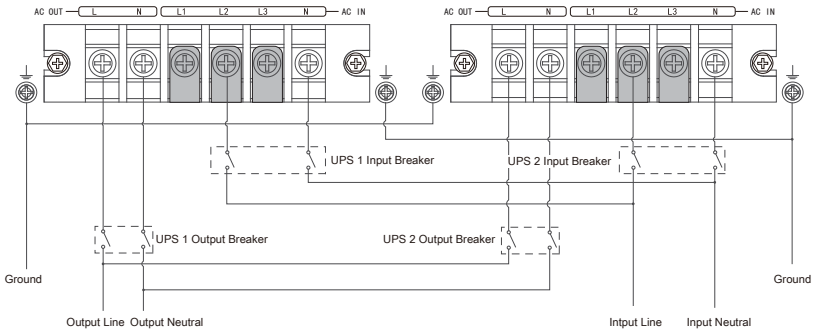

To ESD common switch

3-1 mode

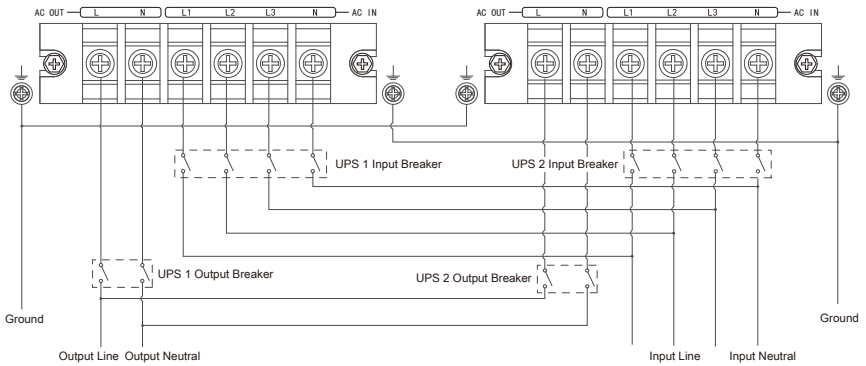

To ESD common switch

5.6.2. Wiring for parallel signal cable

Parallel signal cable connection diagram:

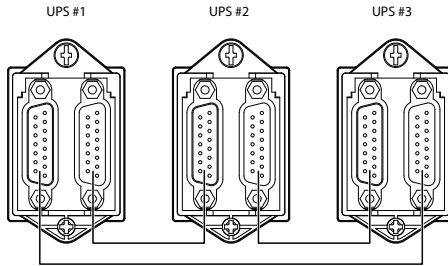

Remove the cover of 'parallel box', then connect each UPS one by one with 'parallel cable', make sure the cable is screwed to parallel port tightly.

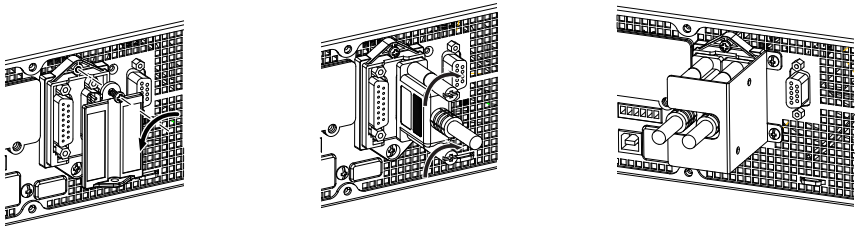

It is recommended to lock the 'parallel cable' (as above) for preventing the parallel ports suffering an unexpected pulling-force and causing the parallel system fault.

5.6.3. Parallel system Operation

Turn on the input breakers for the parallel UPS. Pressing  button continuously for one UPS of the system, then the system will start and enter in line mode (if auto bypass = enable) and the system will work normally in parallel.

6. OPERATION



Remove the display protective film

6.1. Starting the UPS using mains power

1



Power on with utility

2

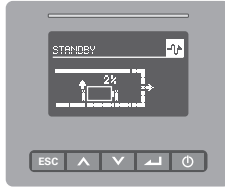

Auto standby mode

3

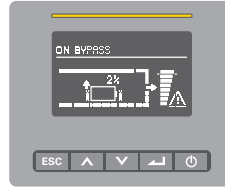

Auto bypass mode (enabled)

4

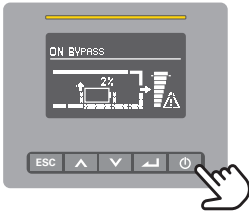

5

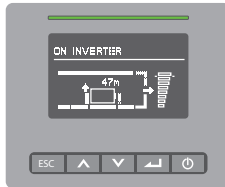

UPS on inverter

6.2. Starting the UPS using battery power



Before using this feature, the UPS must have been powered by the mains power supply with output enabled at least once.

Battery start can be disabled. Refer to page 26 chapter “3.8. User settings - Cold start”.

1



Touch  for power on

2

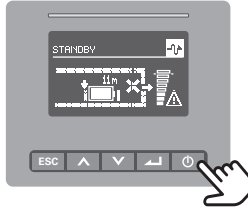

3

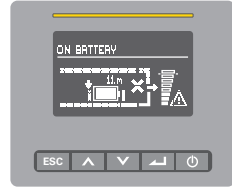

UPS in Battery mode

6.3. UPS shutdown

1

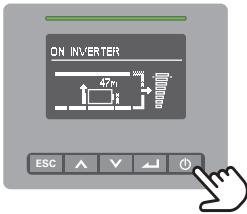

2

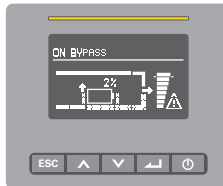

UPS on bypass mode (enable)

3

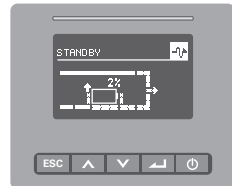

Disconnect mains

4

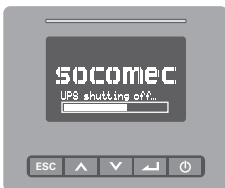

UPS shutting off

5



Complete shutdown

7. UPS MAINTENANCE

7.1. Equipment care

For the best preventive maintenance, keep the area around the equipment clean and dust free. If the atmosphere is very dusty, clean the outside of the system with a vacuum cleaner.

For full battery life, keep the equipment at an ambient temperature of 25°C (77°F).



Note: the batteries are rated for a 3-5 year service life. The length of service life varies, depending on the frequency of usage and ambient temperature. Batteries used beyond expected service life will often have severely reduced runtimes. Replace batteries at least every 4 years to keep units running at peak efficiency.

7.2. Transporting the UPS



Note: please transport the UPS only in the original packaging. If the UPS requires any type of transportation, check that the UPS is disconnected and turned off.

7.3. Storing the equipment

If you store the equipment for a long period, recharge the battery every 6 months by connecting the UPS to the mains power supply. It is recommended that the batteries are charged until the batteries are fully charged (see Battery Status on LCD) after long-term storage.

If the batteries have not been charged over a six-month period, do not use them. Contact your service representative.

8. TROUBLESHOOTING



The UPS is designed for durable, automatic operation and also alerts you whenever potential operating problems may occur. Usually the alarms shown by the control panel do not mean that the output power is affected. Instead, they are preventive alarms intended to alert the user.

- Events are silent status information that are recorded into the Event log. Example = “Battery charging”.
- Alarms are recorded into the Event log and displayed on the LCD status screen with the logo blinking. Some alarms may be announced by a beep every 1 second. Example = “Battery low”.
- Faults are announced by a continuous beep and red LED, recorded into the Event log. Example = Out. short circuit.

Use the following troubleshooting chart to determine the UPS alarm condition.

8.1. Typical alarms and faults

To check the UPS mode and History log:

1. Press any button on the front panel display to activate the menu options.
2. Press  on the menu of "History log".
3. Scroll through the listed events or faults.
4. Press  on the menu of "UPS mode" for current alarms.

The following table describes typical conditions.

WARNING		
PROBLEM DISPLAYED	POSSIBLE CAUSE	REMEDY
On Maintain Bypass	Maintenance bypass switch is open	Check the maintenance bypass switch status
Site Wiring alarm	Phase and neutral conductor at input of UPS system are reversed	Reverse mains power wiring.
No battery	Battery pack is not connected correctly	Do the battery test to confirm. Check the battery bank is properly connected to the UPS Check the battery breaker is turned on or fuse OK.
Battery low	Battery voltage is low	When audible alarm sounding every second, battery is almost empty.
End battery life	The battery has reached the end of its life	Consult dealer if to replace the battery
Power overload	Power requirements exceed the UPS capacity	Check the loads and remove some noncritical loads. Check if some loads have failed
Overload pre-alarm	The load exceeds the preset value	Check the loads or reset the pre-alarm value
Fan lock	Fan abnormal	Check if the fan is running normally or fan detection cable disconnected
UPS temp. alarm	Inside temperature of UPS is too high	Check the ventilation of UPS and the ambient temperature.
Amb. temp. alarm	The ambient temperature is too high	Check the environment ventilation
Imminent shutoff	Insufficient battery backup time	Protect load equipment in time

FAULT		
PROBLEM DISPLAYED	POSSIBLE CAUSE	REMEDY
Inverter overload	Overload	Check the loads and remove some noncritical loads. Check if some loads have failed.
Bypass overload	Overload	Check the loads and remove some noncritical loads. Check if some loads have failed.
Out. short circuit	Abnormally low impedance placed on its output and considers it a short circuit	Remove all the loads. Turn off the UPS. Check if the UPS outputs L and N are short circuited, or if the loads are faulted (in short circuit). Ensure short circuit is removed before turning on again.
UPS temp. fault	Inside temperature of UPS is too high	Check the ventilation of UPS and the ambient temperature.
DC bus + or - too high	UPS internal fault, the + or -DC BUS voltage is too high	Consult dealer.
DC bus + or - too low	UPS internal fault, the + or -DC BUS voltage is too low	Consult dealer.
DC bus unbalanced	UPS internal fault, the voltage difference between DC Bus+ and DC bus- is too large	Consult dealer.
DC bus short circ.	UPS internal fault	Consult dealer.
Max inverter volt	UPS internal fault, the inverter voltage is too high	Consult dealer.
Min inverter volt	UPS internal fault, the inverter voltage is too low	Consult dealer.

OTHER CASES		
PROBLEM DISPLAYED	POSSIBLE CAUSE	REMEDY
No indication, no warning tone even though system is connected to mains power supply	No input voltage	Check the building wiring and input cable. Check if the input breaker is closed.
Yellow LED bar even though the power supply is available	Inverter not switched on	Press On-Switch to turn on UPS.
Emergency supply period shorter than nominal value	Batteries are not fully charged / batteries defect	Charge the batteries for at least 12 hours and then check capacity.

8.2. Silencing the alarm

Press the ESC (Escape) button for 3s on the front panel display to mute the alarm. Check the alarm condition and perform the applicable action to resolve the condition. If the alarm status changes or if the used press the "esc" button on the front panel for 3 seconds, the alarm beeps again, overriding the previous alarm silencing.

9. SPECIFICATIONS

9.1. UPS block diagram

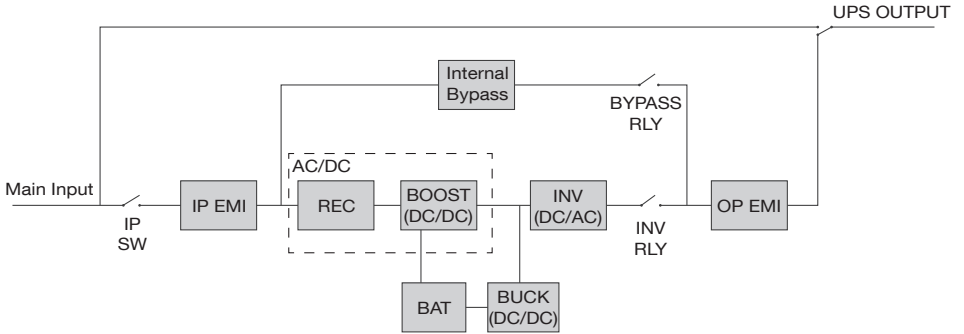

9.2. UPS specifications

MODELS		NRT4-U050...	NRT4-U060...	NRT4-U060LB...	NRT4-U080...	NRT4-U100...	NRT4-U100LB...	NRT4-U108...	NRT4-U110...	NRT4-U110LB...
Referred also as		5K	6K	6LB	8K5	10K	10LB	8K5 (3:1)	10K (3:1)	10LB (3:1)
Rated power ⁽¹⁾		5 kVA 5 kW	6 kVA 6 kW	6 kVA 6 kW	8.5 kVA 8.5 kW	10 kVA 10 kW	10 kVA 10 kW	8.5 kVA 8.5 kW	10 kVA 10 kW	10 kVA 10 kW
Rated frequency		50 / 60 Hz								
Input	Voltage range (Phase voltage)	<p style="text-align: center;">110 VAC-276 VAC</p>								
	Rated voltage (Phase voltage)	220/230/240VAC								
	Max. current (1phase) with 16pcs battery ⁽²⁾	29 A	34 A	42 A	-	-	-	-	-	-
	Max. current (1phase) with 20pcs battery ⁽²⁾	-	-	-	47 A	54 A	65 A	47 A	54 A	65 A
	Max. current (3phase) with 20pcs battery ⁽²⁾	-	-	-	-	-	-	L1 42 A L2/L3 16 A	L1 49 A L2/L3 19 A	L1 52 A L2/L3 22 A
	Frequency range	40-70 Hz @LOAD ≤ 60%								
		45-55 Hz (50 Hz system) / 54-66 Hz (60 Hz system) @LOAD > 60%								
	Power Factor	> 0.99 full resistive load ⁽³⁾								
	THDi	< 3% full resistive load ⁽³⁾								
	Connection	Terminal Block								
Electrical input supply system	TN, TT, IT									
Charging current ⁽¹⁾	Range	1÷4 A	1÷4 A	2÷12 A	1÷4 A	1÷4 A	2÷12 A	1÷4 A	1÷4 A	2÷12 A
	Default	1.4 A	1.4 A	4 A	2 A	2 A	4 A	2 A	2 A	4 A

MODELS		NRT4-U050...	NRT4-U060...	NRT4-U060LB...	NRT4-U080...	NRT4-U100...	NRT4-U100LB...	NRT4-U108...	NRT4-U110...	NRT4-U110LB...	
Output	Rated voltage (Phase voltage)	220/230/240 VAC									
	Overload on normal mode	105%-125% Load, 10 minutes transfer to Bypass; 125%-150% Load, 30 seconds transfer to Bypass; >150% Load, 0.5 seconds transfer to Bypass									
	Short-circuit current on normal mode for 200ms max	54 A for 200 ms max	54 A for 200 ms max	54 A for 200 ms max	113 A for 200 ms max	113 A for 200 ms max	113 A for 200 ms max	113 A for 200 ms max	113 A for 200 ms max	113 A for 200 ms max	113 A for 200 ms max
	Frequency	50 / 60 Hz ± 0.1 Hz									
	THDv	< 1% resistive load									
Crest Factor		3:1									
Transfer Time Line <-> Battery		0 ms									
Transfer Time INV <-> Bypass		0 ms									
BATTERY											
Battery voltage		192 VDC (5K/6K/6LB) 240 VDC [8.5K / 10K / 10LB / 10K (3-1) / 10LB (3-1)]									
Battery number		16 PCS (5K/6K/6KS) 20 PCS [8.5K / 10K / 10LB / 10K (3-1) / 10LB (3-1)]									
ENVIRONMENT											
Ambient temperature		0 ÷ 45 °C									
Relative humidity		0 ÷ 95% (no condensing)									
Operating altitude		< 3000 m (Derating use above 1 km, the load should de-rating 1% every up 100 m)									
Storage temperature (with battery)		-15 °C ÷ 40 °C									
Storage temperature (without battery)		-25 °C ÷ 55 °C									
Acoustic noise		< 50 dB @70% load				< 55 dB @70% load					
STANDARDS											
Safety		IEC/EN 62040-1, AS 62040.1									
EMC		IEC/EN 62040-2, AS IEC 62040.2									
Performance		IEC/EN 62040-3									
(1) In free running mode and converter mode, UPS needs to be de-rated to 60% capacity (rated output power and maximum charging current). (2) @ 220VAC input phase voltage, rated output power and maximum charging. (3) 1:1 connection											

China RoHS

产品中有害物质的名称及含量

Name and content of hazardous substances in products

部件名称 COMPONENT NAME	有害物质 HAZARDOUS SUBSTANCE					
	铅 (Pb) LEAD (Pb)	汞 (Hg) MERCURY (Hg)	镉 (Cd) CADMIUM (Cd)	六价铬 (Cr (VI)) HEXAVALENT CHROMIUM (Cr (VI))	多溴联苯 (PBB) POLYBROMINATED BIPHENYLS (PBB)	多溴二苯醚 (PBDE) POLYBROMINATED DIPHENYL ETHERS (PBDE)
电池类 BATTERY	×	○	○	○	○	○
印刷电路组件 PCBA	×	○	○	○	○	○
电源线插座端子 WIRE TERMINAL	×	○	○	○	○	○
箱体五金类 HARDWARE	×	○	○	○	○	○
开关/断路器类 SWITCH, BREAKER, ETC.	○	○	×	○	○	○

本表格依据 SJ/T 11364 的规定编制。

○：表示该有害物质在该部件所有均质材料中的含量均在GB/T 26572规定的限量要求以下。

×：表示该有害物质至少在该部件的某一均质材料中的含量超出GB/T 26572规定的限量要求。

环保使用期限的免责条款：环保使用期限规定的具体期限仅为符合中华人民共和国的相应的法律规定，并非代表我司向客户提供保证或负有任何义务。环保使用期限中假定客户按照操作手册在正常情况下使用本产品。对于本产品中配备的某些组合件（例如，装有电池的组套件）的环保使用期限，可能低于本产品的环保使用期限。

This table was drawn up according to the provisions of SJ/T 11364.

○: The content of these hazardous substances in all homogeneous materials of these components is below the limit required by the directive GB/T 26572

×: The content of these hazardous substances in certain homogeneous materials of these components is higher than the limit required by the directive GB/T 26572

Environmental Protection Use Period (EPUP) Disclaimer: The number provided as the EPUP is provided solely to comply with applicable laws of the People's Republic of China. It does not create any warranties or liabilities on behalf of our company to customers. The EPUP assumes that the product will be used under normal conditions in accordance with the operating manual. Certain assemblies inside this product (for example, assemblies that contain a battery) may have an EPUP which is lower than the EPUP on this product.

MAIN OFFICE, CONTACT:
SOCOMECSAS
1-4 RUE DE WESTHOUSE
67235 BENFELD, FRANCE



552935A - EN 06.2024

www.socomec.com

Non contractual document. © 2024, Socomec SAS. All rights reserved.



 **socomec**
Innovative Power Solutions